

## Expansion IO Card Option 2

---

### ETB004Z Instruction manual

---



#### NOTICE

1. Make sure that this instruction manual is delivered to the end user of the expansion IO card option.
2. Read this manual before installing or operating the expansion IO card option. Keep it in a safe place for reference.
3. All information contained in this manual are subject to change without notice. Please confirm the latest information on our web site "[www.inverter.co.jp](http://www.inverter.co.jp)".

## Safety precautions

On the inverter and in its instruction manual, important information is contained for preventing injuries to users and damages to assets and for proper use of the device. Read the instruction manual attached to VF-AS1/PS1 along with this instruction manual for completely understanding the safety precautions and adhere to the contents of these manuals.



### Explanation of markings

Marking	Meaning of marking
 Warning	Indicates that errors in operation may lead to death or serious injury.
 Caution	Indicates that errors in operation may lead to injury (*1) to people or that these errors may cause damage to physical property. (*2)

(\*1) Such things as injury, burns or shock that will not require hospitalization or long periods of outpatient treatment.

(\*2) Physical property damage refers to wide-ranging damage to assets and materials.







### Meanings of symbols

Marking	Meaning of marking
	Indicates prohibition (Don't do it). What is prohibited will be described in or near the symbol in either text or picture form.
	Indicates something mandatory (must be done). What is mandatory will be described in or near the symbol in either text or picture form.
	Indicates danger or warning. What is dangerous, or what the warning should be applied to will be described in or near the symbol in either text or picture form.



■ Limitation of use

 <b>Safety precaution</b>	
▼ Never use this unit with any device other than TOSVERT VF-AS1/PS1 series inverters. Doing so may cause an accident.	



■ General Operation

 <b>Warning</b>	
 Disassembly prohibited	▼ Never disassemble, modify or repair. Doing so could result in electric shock, fire and injury. For repairs, call your sales agency.
 Prohibited	▼ Do not attach this option to any inverter other than the VF-AS1/PS1. Doing so could result in electric shock or fire. ▼ Don't place or insert any kind of object into the ETB004Z (electrical wire cuttings, rods, wires). Doing so could result in electric shock or fire. ▼ Do not allow water or any other fluid to come in contact with the ETB004Z. Doing so could result in electric shock or fire.
 Mandatory	▼ If the inverter begins to emit smoke or an unusual odor, or unusual sounds, immediately turn off the VF-AS1/PS1. If the equipment is continued in operation in such a state, the result may be fire. Call your local sales agency for repairs. ▼ Do not touch the sharp portions (such as leads of parts on the board, the corner of board, or etc.) on this option. It may lead to injuries.
 <b>Caution</b>	
 Mandatory	▼ This option is an electrostatic discharge sensitive device. Handle it, where the environment is protected against electrostatic electricity. Otherwise, permanent damage to device will result.



■ Transportation & installation

 <b>Warning</b>	
 Prohibited	▼ Do not apply a dropping shock or other physical shocks. Otherwise, damage or malfunction will result. ▼ Do not install or operate the inverter if it is damaged or any part of it is missing. Operating a defective inverter may lead to electric shocks or fire. For repairs, call your sales/repair agency. ▼ Do not put any flammable material near the product. It may catch fire due to the product sparking in the case of a malfunction.
 Mandatory	▼ Use this product under the environmental conditions prescribed in the instruction manual. Usage it under any other conditions may result in malfunction. ▼ An emergency stop device must be installed that fits with system specifications (e.g. shut off input power then engage mechanical brake). Operation cannot be stopped immediately by the inverter or this unit alone, thus risking an accident or injuries.



### ■ Wiring

 <b>Caution</b>	
 Mandatory	<ul style="list-style-type: none"> <li>▼ Electrical construction work must be done by a qualified expert. Installation or connection of input power by someone who does not have that expert knowledge may result in fire or electric shock.</li> <li>▼ Shut off power when installing and wiring this option. Wait at least 15 minutes and check to make sure that the charge lamp (VF-AS1/PS1) is no longer lit.</li> <li>▼ Tighten the screws on the terminal block to the specified torque (Refer to Section 2.2). If the screws are not tightened to the specified torque, it may lead to fire.</li> </ul>

### ■ Operations

 <b>Warning</b>	
 Prohibited	<ul style="list-style-type: none"> <li>▼ Do not pull on any cable itself. Doing so could result in damage or malfunction.</li> <li>▼ Do not touch switches when the hands are wet and do not try to clean the inverter with a damp cloth. Doing so could result in electric shock.</li> </ul>
 Mandatory	<ul style="list-style-type: none"> <li>▼ Use this option under the environment specified in the instruction manual. Usage under the environment other than them may cause damages or malfunctions or an accident.</li> <li>▼ Use an additional safety device with your VF-AS1/PS1 or system to prevent a serious accident due to the unit malfunctions. Usage without an additional safety device may cause an accident.</li> </ul>

### ■ Disposal

 <b>Caution</b>	
 Mandatory	<ul style="list-style-type: none"> <li>▼ For safety's sake, do not dispose of the disused inverter yourself but ask an industrial waste disposal agent (*). If the collection, transport and disposal of industrial waste is done by someone who is not licensed for that job, it is a punishable violation of the law. (Laws in regard to cleaning and processing of waste materials) (* ) Persons who specialize in the processing of waste and known as "industrial waste product collectors and transporters" or "industrial waste disposal persons."</li> </ul>

### ■ Notes on use

<b>Notes</b>	
	<ul style="list-style-type: none"> <li>▼ Do not install the inverter where the temperature or the humidity will change rapidly.</li> <li>▼ Keep a distance of 20cm or more between the inverter's power cable and the data transmission cable. Or the inverter might malfunction because of noise.</li> <li>▼ Insert a magnetic contactor or similar device between the VF-AS1/PS1 and the power supply to ensure that power is turned off if an emergency stop command is entered through the network.</li> </ul>

## Introduction

Thank you for purchasing a “Expansion IO card option 2” for industrial inverter TOSVERT VF-AS1/PS1 inverter.

By the use of this option, the expansion of input/output terminal is possible. This instruction manual describes connecting method and usage of the “Expansion IO card option”. Read this manual carefully before using the unit.

Keep this manual near at hand of the operator who uses the “Expansion IO option” for future reference in the maintenance and inspection.

### ■ Type of expansion IO option card

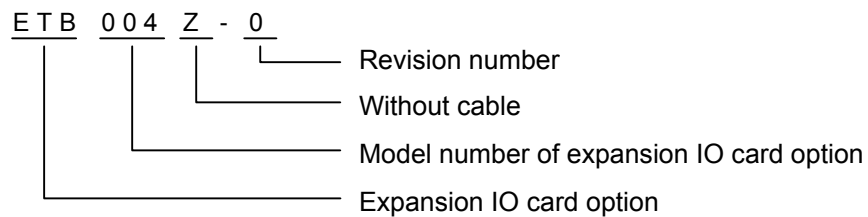

### ■ Confirmation on accessories

Following accessory parts are included in the expansion IO card option.

Upon unpacking, confirm on the following parts.

Expansion IO card option unit

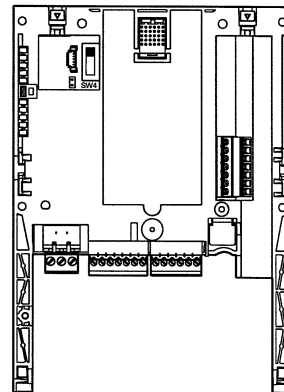

(1) Instruction manual of expansion IO card option (this manual)

E6581341(English)

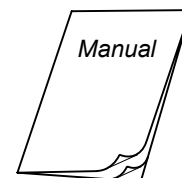

---

# Contents

---

1. Name and function of each section .....	6
1.1. Appearance .....	6
1.2. Name of each section (terminal) .....	6
2. Installing the IO card option in the VF-AS1/PS1 .....	7
2.1. Connection to the inverter .....	7
2.2. Wiring .....	8
3. Functional description .....	10
3.1. Multi-function output terminal .....	10
3.2. Multi-function input terminal .....	11
3.3. -10V power supply.....	11
3.4. Multi-function analog output .....	12
3.5. Differential current input (AI1+, AI1-) .....	12
3.6. Analog input (AI2).....	13
3.7. External thermal trip input (TH2+, TH2-).....	13
3.8. Pulse train input (RP) .....	14
4. External diagram .....	15
5. Specification .....	16
6. Warranty.....	17

# 1. Name and function of each section

Following figure shows appearance and name of each section of the expansion IO card option.

## 1.1. Appearance

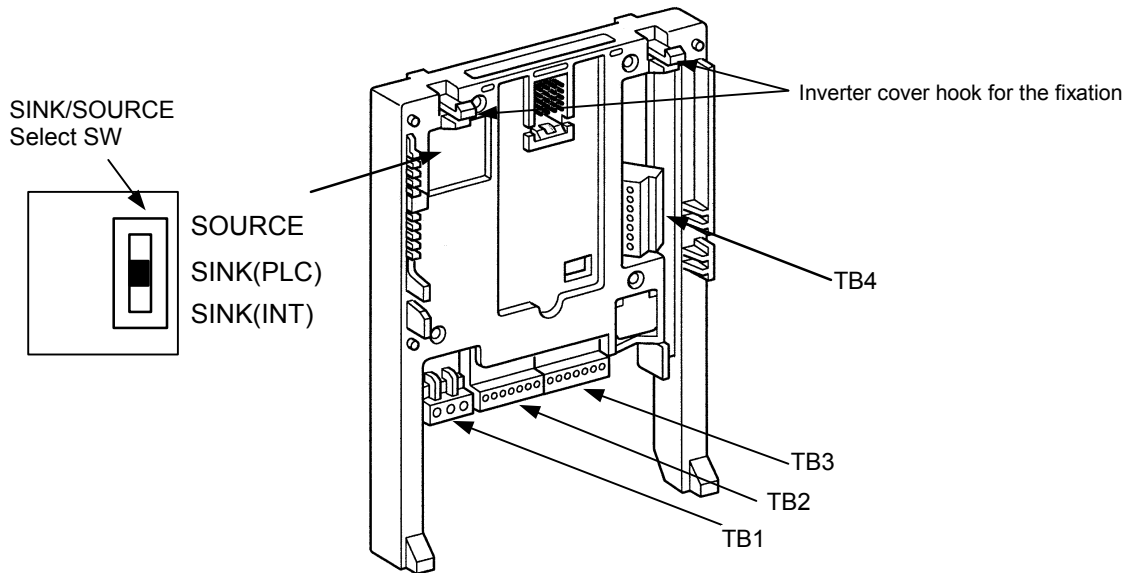

## 1.2. Name of each section (terminal)

T B 1	R2A	Programmable relay output 2
	R2B	Programmable relay output 2
	R2C	Programmable relay output 2

T B 2	N10	Analog input setting power output -10V
	AI1+	Differential analog current input (+)
	AI1-	Differential analog current input (-)
	AI2	Current or voltage analog input
	CCA	Analog input/output signal equipotential (0V)
	MON1	Multifunction programmable analog output 1
	MON2	Multifunction programmable analog output 2

T B 3	P24/PLC	Common terminal of extension terminal input
	LI5	Extension terminal input LI5
	LI6	Extension terminal input LI6
	LI7	Extension terminal input LI7
	LI8	Extension terminal input LI8
	CC	Digital signal equipotential (0V)

T B 4	TH2+	PTC input terminal (+)
	TH2-	PTC input terminal (-)
	RP	Pulse train input terminal
	OUT5	Multifunction programmable open collector output 5
	OUT6	Multifunction programmable open collector output 6
	NO2	Output 5 and 6 common terminal
CC	Digital signal equipotential (0V)	

## 2. Installing the IO card option in the VF-AS1/PS1

### 2.1. Connection to the inverter

(1) Turn off input power before installing.



Mandatory

Turn off the input power of VF-AS1/PS1 and wait for at least 15 minutes and then check that the CHARGE lamp on VF-PS1 is no longer lit.

(2) Securing the option to the inverter

- a) Insert a flat-blade screwdriver in each of the two holes at the upper part of the front panel, release the panel mounting tab by pushing the screwdriver down, and remove the front panel cover.
- b) Install the option in the inverter by fitting the tabs on the lower side of the option into the slots at the lower part of the inverter front panel.
- c) Make sure the option is securely attached to the inverter. Then, check whether the plastic bosses on the inverter case have fitted in the holes at the upper and lower parts of the option\*.
- d) Insert the tabs at the lower part of the front cover into the slots at the lower part of the inverter to attach the front cover to the inverter.

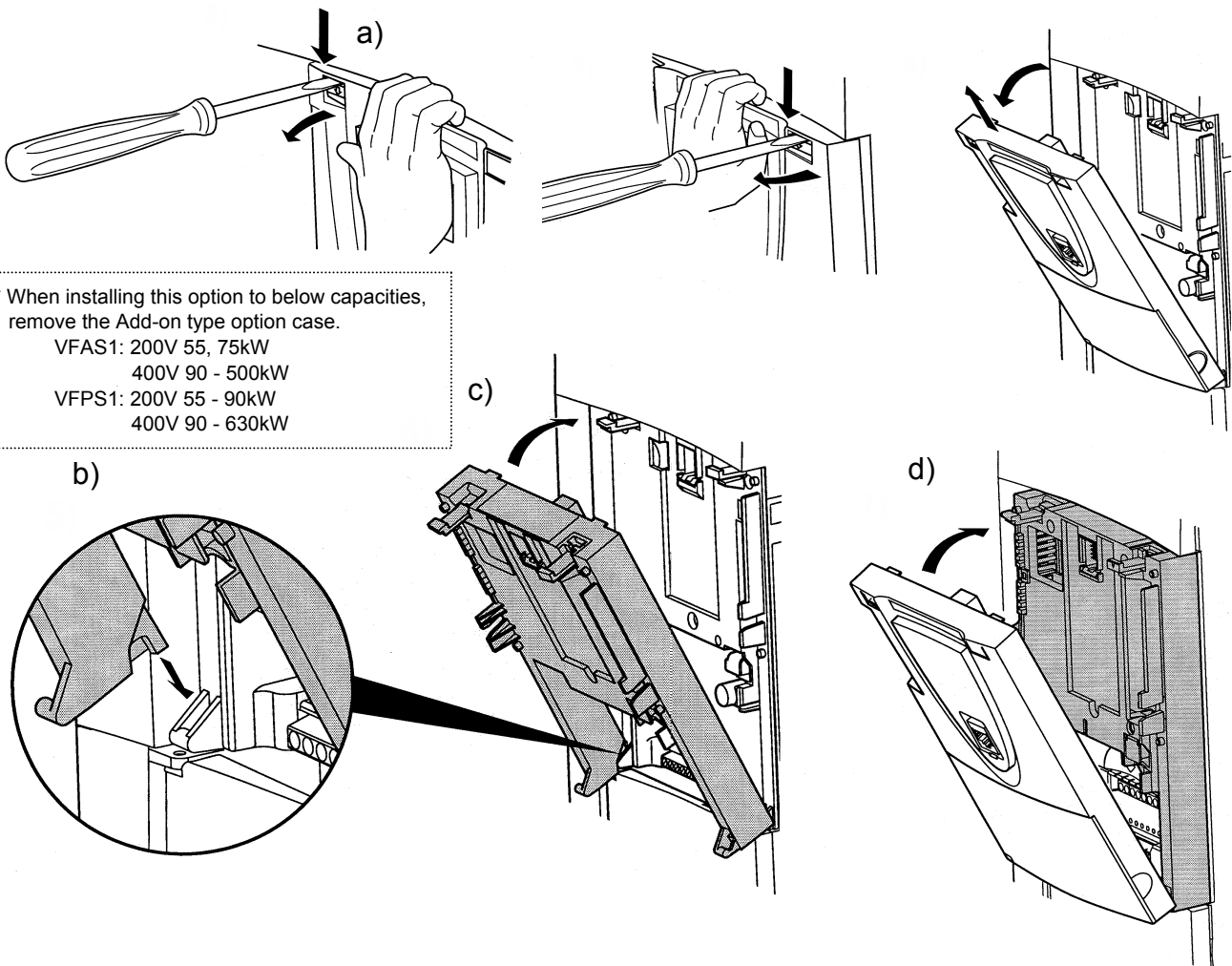

## 2.2. Wiring

When conducting wiring, follow the instructions below.

- Use shield wire for control signal line and ground the unit with shield wire.  
(Use twisted pair shield cable for wiring of the analog monitor output.)
- Applicable wire size ..... TB1: 0.2 to 2.5 mm<sup>2</sup>  
TB2 to TB4: 0.2 to 1.5mm<sup>2</sup>
- The wire length of peel off the end ..... TB1: About 5mm  
TB2 to TB4: About 7mm
- Using screwdriver ..... TB1: The blade tip has 0.6mm thickness  
and 3.5mm width.  
TB2 to TB4: The blade tip has 0.4mm thickness  
and 2.5mm width.
- Tightening torque of the terminal block ..... TB1: 0.5 to 0.6 N·m  
TB2 to TB4: 0.22 to 0.25 N·m
- Never bind the signal line and main circuit connection wire together.

### ■ < Input/output terminal interface >

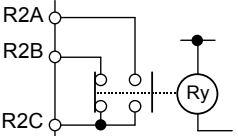
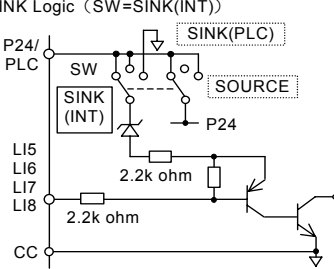
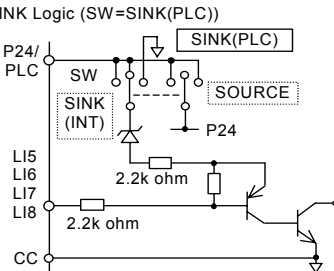
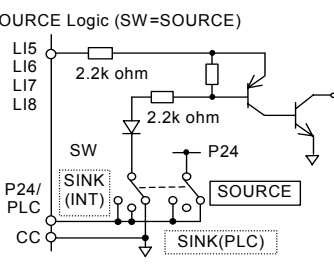
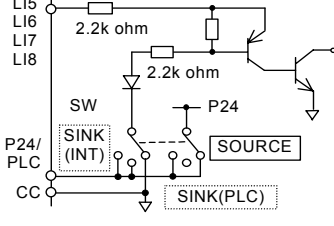
Terminal symbol	Function	Electrical specification	Internal circuit
R2A R2B R2C	Relay contact point output	Configuration of 1C contact point 250Vac - 2A (cos $\phi$ =1) 250Vac - 1A (cos $\phi$ =0.4) 30Vdc - 1A	
LI5 LI6 LI7 LI8	Contact point input Changeover of sink or source	No voltage contact input 24Vdc - 5mA Sink input(common voltage 24V) ON : less than 10Vdc OFF : 16Vdc or more Source input ON : 11Vdc or more OFF : less than 5Vdc <b>Note:</b> <u>Even when an external power supply is used (in sink logic mode i.e. when SINK(PLC) is selected), connect the reference potential-side (0V side) cable from the power supply to the CC terminal.</u> <div style="border: 1px dashed black; padding: 5px; width: fit-content; margin: 10px auto;">Lan current signal. Chose low current contacts to avoid poor attaching.</div>	<p>SINK Logic (SW=SINK(INT))</p>  <p>SINK Logic (SW=SINK(PLC))</p>  <p>SOURCE Logic (SW=SOURCE)</p> 
PLC/ P24	24V power supply	24Vdc power output (when SW1 is in any position other than PLC) 24V internal output terminal 24Vdc - 60mA max	
	Common terminal for external power supply	If SW1 is turned to the PLC position, this terminal can be used as a common terminal when an external power supply is used.	

Terminal symbol	Function	Electrical specification	Internal circuit
TH2+ TH2-	Thermal trip input	The resistance between TH2+ and TH2- Tripping value: about under 50 ohm or over 3k ohm Reset value: about 1.8k ohm	
N10	-10V power supply	DC-10V - 10mA	
OUT5 OUT6 NO2	Multifunction programmable open collector output.	Open collector output Drive current External power supply used : 50mA Internal power supply used : 20mA Drive voltage 12V min - 30V max Isolated other circuit.	
CC	Common to input/output	Digital signal equipotential (0V) terminal for the control circuit	—
AI1+ AI1-	Differential current input	Current input : Equal or under 20mA Voltage : Differential input voltage under 5V Input voltage from -10V to 10V	
AI2+ CCA	Analog input	Current input : Equal or under 20mA Voltage input : 0 to 10V	
MON1 MON2	Monitor output	Multifunction programmable analog output. -10V - 10V output 0V - 10V output 0mA - 20mA output	
RP	Pulse train input	Input pulse Voltage : 5Vmax Current : 15mA max Frequency : 30kHz max Duty : 50 ± 10% The resistor is needed when input voltage is over 5V to 30V if the current is under maximum current.	 Vf = 1.3 - 1.85V (at 10mA) Von > 3.5V Voff < 1.2V

## 3. Functional description

In this section, functions added by the installation of this expansion IO card option, on top of the standard inverter functions, are described.

Note: When power on or reset the inverter, the initialization of the ETB004Z terminal inputs and outputs are delayed about 300ms from the inverter own terminals.

### 3.1. Multi-function output terminal

Two output terminals and one relay output can be added. Function is similar to that of the output terminals of the inverter, so refer to the inverter instruction manual.

#### ■ Parameter

Title	Function	Adjustment range	Default setting
<i>F 136</i>	Output terminal function selection 7 (OUT5)	0 - 255	254 (Always OFF)
<i>F 137</i>	Output terminal function selection 8 (OUT6)	0 - 255	254 (Always OFF)
<i>F 138</i>	Output terminal function selection 9 (R2)	0 - 255	254 (Always OFF)

#### ■ Monitor

Refer to the description on status monitor mode of inverter's instruction manual.

The output terminal status can be monitored by the output terminal status parameter (*F E 0 7*), and the parameter can be monitor by the serial communication.

*F E 0 7*

bit No.	15	14	13	12	11	10	9	8	7	6	5	4	3	2	1	0
Symbol	---	---	---	---	---	---	---	R2	OUT 6	OUT 5	R1	OUT 4	OUT 3	FL	OUT 2	OUT 1

Note: The OUT3, OUT4 and R1 are the terminal function of the expansion IO card option 1.

### 3.2. Multi-function input terminal

Four output terminals can be added. Function is similar to that of the input terminals of the inverter, so refer to the inverter instruction manual.

#### ■ Parameter

Title	Function	Adjustment range	Default setting
<i>F 123</i>	Input terminal selection 13 (LI5)	0 - 135	0
<i>F 124</i>	Input terminal selection 14 (LI6)	0 - 135	0
<i>F 125</i>	Input terminal selection 15 (LI5)	0 - 135	0
<i>F 126</i>	Input terminal selection 16 (LI5)	0 - 135	0
<i>F 145</i> *	Input terminal 13 - 20 response time selection	5 - 200ms	8

\* VF-PS1 does not have this parameter.

#### ■ Monitor

Refer to the description on status monitor mode of inverter's instruction manual.

The input terminal status can be monitored by the input terminal status parameter (*F E 0 6*), and the parameter can be monitor by the serial communication.

*F E 0 6*

bit No.	15	14	13	12	11	10	9	8	7	6	5	4	3	2	1	0
Symbol	LI8	LI7	LI6	LI5	LI4	LI3	LI2	LI1	S4	S3	S2	S1	RES	ST	R	F

Note: The LI1 ~ LI4 are the terminal function of the expansion IO card option 1.

### 3.3. -10V power supply

The frequency command can be input from RX terminal with pulse and negative voltage using N10(-10V) and PP(+10V) power.

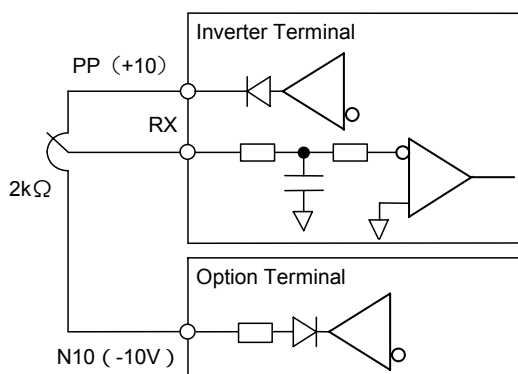

Potentiometer

Center position: 0V command

Pulse side position: +10V command

Negative side position: -10V command

The recommended wiring cable length is less than 1.5m with shielded cable.

### 3.4. Multi-function analog output

MON1, MON2 terminal output +/-10V, 0 - 10V, 0 - 20mA (4 - 20mA) analog signal.

Example : MON1 output (0 - 10V)

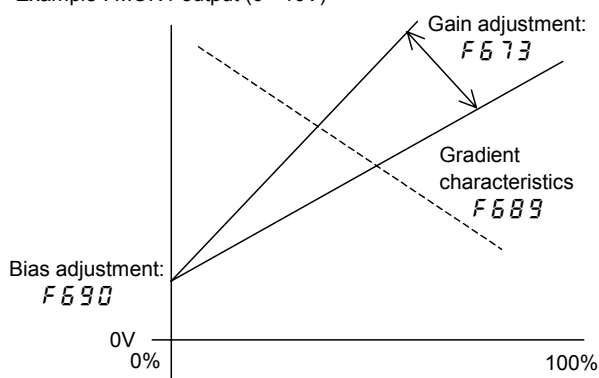

Example : MON1 output (-10V - 10V)

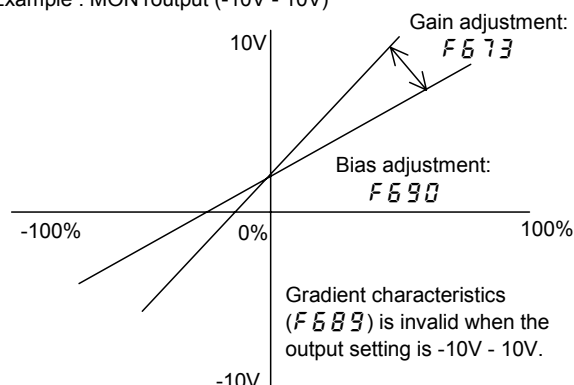

#### Parameter

Title	Function	Adjustment range	Default setting
F672	MON1 terminal meter selection	0 - 64 (4: Output voltage)	4
F673	MON1 terminal meter adjustment	---	---
F674	MON2 terminal meter selection	0 - 64 (5: Compensated frequency)	5
F675	MON2 terminal meter adjustment	---	---
F688	MON1 voltage/current output switching	0: Voltage -10 - 10V output 1: Voltage 0 - 10V output 2: Current 0 - 20mA output	1
F689	MON1 output gradient characteristic	0: Negative inclination (downward slope) <sup>Note1</sup> 1: Positive inclination (upward slope)	1
F690	MON1 bias adjustment	-10.0 - 100.0%	0.0
F691	MON1 voltage/current output switching	0: Voltage -10 - 10V output 1: Voltage 0 - 10V output 2: Current 0 - 20mA output	1
F692	MON2 output gradient characteristic	0: Negative inclination (downward slope) <sup>Note1</sup> 1: Positive inclination (upward slope)	1
F693	MON2 bias adjustment	-10.0 - 100.0%	0.0

Note1: When MON1 (MON2) setting is the voltage -10 - 10V output, F689 (F689) setting is invalid and the MON1 (MON2) gradient characteristics becomes the positive inclination.

### 3.5. Differential current input (AI1+, AI1-)

The frequency command can be input from the differential current input AI1 and AI2 terminal current. Keep the each terminal voltage from CC terminal from -10V to 10V, and keep voltage under 5V between each terminal.

### Parameter

Title	Function	Adjustment range	Default setting
<i>F222</i>	AI1 input point 1 setting	-100 - 100%	0
<i>F223</i>	AI1 input point 1 frequency	0.0 - <i>FH</i> Hz	0.0
<i>F224</i>	AI1 input point 2 setting	-100 - 100%	100
<i>F225</i>	AI1 input point 2 frequency	0.0 - <i>FH</i> Hz	60.0
<i>F226</i> *	AI1 input point 1 rate	-250 - 250% (for torque control etc.)	0
<i>F227</i> *	AI1 input point 2 rate	-250 - 250% (for torque control etc.)	100
<i>F476</i>	Optional AI1 input bias	0 - 255	---
<i>F477</i>	Optional AI1 input gain	0 - 255	---

\* VF-PS1 does not have these parameters.

## 3.6. Analog input (AI2)

The frequency command can be input from the voltage or current analog input.

### Parameter

Title	Function	Adjustment range	Default setting
<i>F109</i>	Analog AI2 (optional circuit board) voltage/current switching	0: Voltage 1: Current	0
<i>F228</i>	AI2 input point 1 setting	0 - 100%	0
<i>F229</i>	AI2 input point 1 frequency	0.0 - <i>FH</i> Hz	0.0
<i>F230</i>	AI2 input point 1 setting	0 - 100%	100
<i>F231</i>	AI2 input point 1 frequency	0.0 - <i>FH</i> Hz	60 (or 50)
<i>F478</i>	Optional AI2 input bias	0 - 255	---
<i>F479</i>	Optional AI2 input gain	0 - 255	---

## 3.7. External thermal trip input (TH2+, TH2-)

By connecting the thermistor to TH2+ and TH2- terminal, when the thermistor value is unusual, the inverter can be trip.

The resistor value between TH2+ and TH2-	Detect condition	Movement
about under 50 ohm	Thermistor short broken detection	<i>OH2</i> trip
about 50 0- about 1.5k ohm	Normal value	---
about 1.8k ohm	Thermistor fault reset	---
about 3k ohm	Thermistor fault detection	<i>OH2</i> trip

### Parameter

Title	Function	Adjustment range	Default setting
<i>F638</i>	PTC thermal selection	0: Deselect 1: Select	0

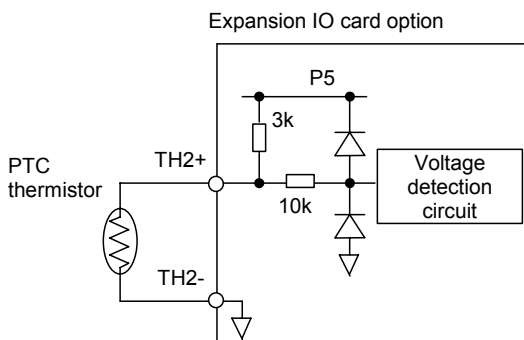

### 3.8. Pulse train input (RP)

The frequency command can be input from the pulse train input.

#### ■ Parameter

Title	Function	Adjustment range	Default setting
<i>F00d</i>	Frequency setting mode selection 1	1 - 12 11: RP pulse input	2
<i>F234</i>	RP/high speed pulse input point 1 setting	-100 - 100%	0
<i>F235</i>	RP/high speed pulse input point 1 frequency	0.0 - <i>FH</i> Hz	0.0
<i>F236</i>	RP/high speed pulse input point 2 setting	0 - 100%	100
<i>F237</i>	RP/high speed pulse input point 2 frequency	0.0 - <i>FH</i> Hz	60.0
<i>F378</i>	Number of RP terminal input	12 - 9999	500
<i>F660</i>	Override additional input selection	0 - 12 11: RP pulse input	0

---

## 4. External diagram

---

Do not forget to reserve the space for the options at time of installation.

■ External diagram of option (unit: mm)

---

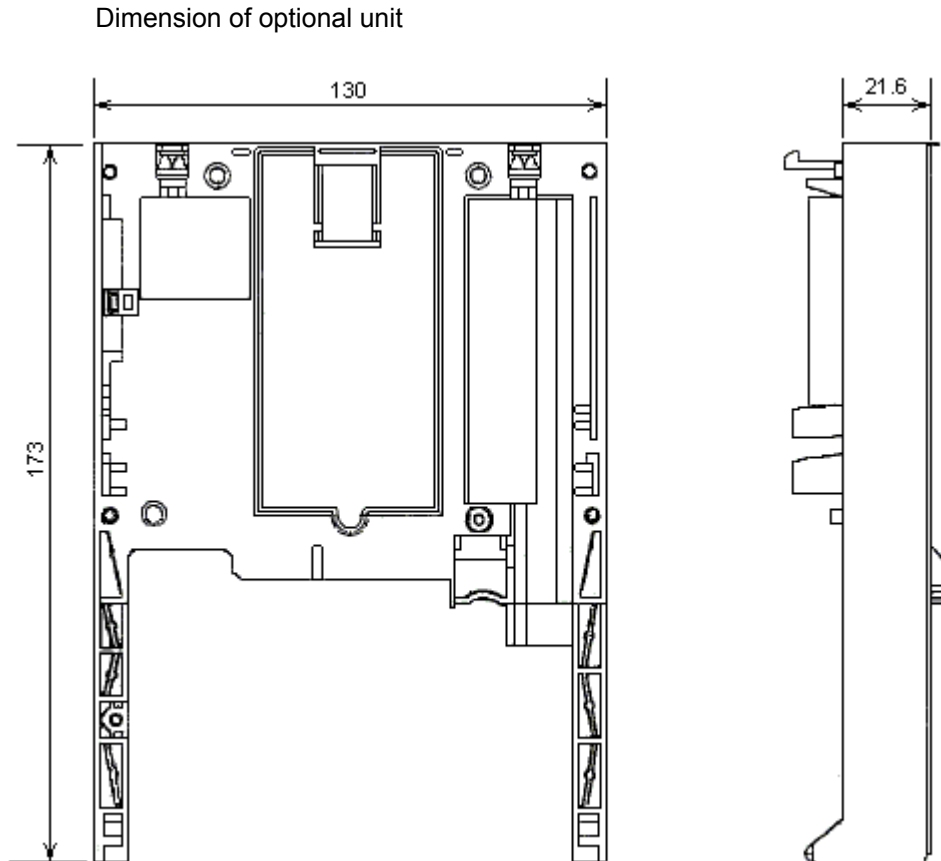

The control panel depth increases about 21.6mm when the option is installed. Secure the front space from the inverter control panel fully. The space which is necessary for the option installation varies in the inverter capacity rate. Please refer to the inverter instruction manual.

## 5. Specification

### <Environment Specification>

Item	Specification
Use Environment	Indoor, less than 3,000 m from the sea level. No direct sunlight, corrosive or explosive gas, steam, cutting dusts or dusts, grinding solution, and grinding oil.
Ambient Temperature	-10 to +60
Storage Temperature	-25 to +65
Relative Humidity	20 to 93 % (No condensation)
Vibration	5.9m/s <sup>2</sup> (0.6G) or less (from 10Hz to 55Hz)

### < Control specification >

Function	Specification
Relay contact output Multi-function programmable output	1 circuits for output of 1C contact point 250Vac - 2A (cos $\phi$ =1) 250Vac - 1A (cos $\phi$ =0.4) 30Vdc - 1A
Contact point input (Changeover of sink / source) Multi-function programmable input	4 contact inputs Sink input (24V common voltage) ON : less than 10Vdc OFF : 16Vdc or more Source input ON : 11Vdc or more OFF : less than 5Vdc
24V power supply	DC24V - 60mA
External thermal trip input	1 circuit. The detection level is below. Tripping value : about 50 ohm or less, or about 3k ohm or more Reset value : about 1.8k ohm
-10V power supply	DC-10V - 10mA
Open collector output Multi-function programmable output	2 circuit Current : 50mA max with external power supply 20mA max with internal power supply Voltage : min. 12V, max 30V
Differential current input	Accuracy : $\pm 0.2\%$ ( $25 \pm 10^\circ\text{C}$ ), Resolution : 11bit Input resistance : 31.2k ohm (voltage input), 242 ohm (current input) Current input : 20mA or less Voltage input : differential voltage input less than 5V -10V or more, and 10V or less
Analog input	Accuracy : $\pm 0.2\%$ ( $25 \pm 10^\circ\text{C}$ ), Resolution : 11bit Input resistance : 31.2k ohm (voltage input), 242 $\Omega$ (current input) Voltage input : 0 - 10V Current input : 20mA or less
Monitor output	2 circuit Voltage output : 0V - 10V $\pm 1\%$ Current output :
Pulse train input	Input pulse Voltage : 5V max Current : 15mA max Frequency : 30kHz max Duty : 50 $\pm$ 10%

---

## 6. Warranty

---

TOSHIBA provides warranty with the product under the following conditions.

1. If and when a trouble occurs on the option unit properly installed and handled within one year of delivery, and if the trouble is clearly attributable to defects inherent in our design and manufacture, the product will be repaired free of charge.
2. The warranty covers only the delivered option unit.
3. Even in the term of the warranty, repair/adjustment service will be charged for the following cases.
  - 1) Fault or damage resulting from misuse, unauthorized modification or repair.
  - 2) Fault or damage resulting from falling down of the product or traffic accident during transportation.
  - 3) Fault or damage originating from fire, salt water/salty breezes, some kind of gas, earthquake, storm or flood, lightning, abnormal supply voltage, other natural disasters.
  - 4) Fault or damage caused by improper use of this option unit as it is used for a purpose out of its original function.
4. If there is another special warranty contracted for this option unit, the special warranty has priority over this warranty.