

# PROGRAMMABLE CONTROLLER PROSEC T2E/T2N

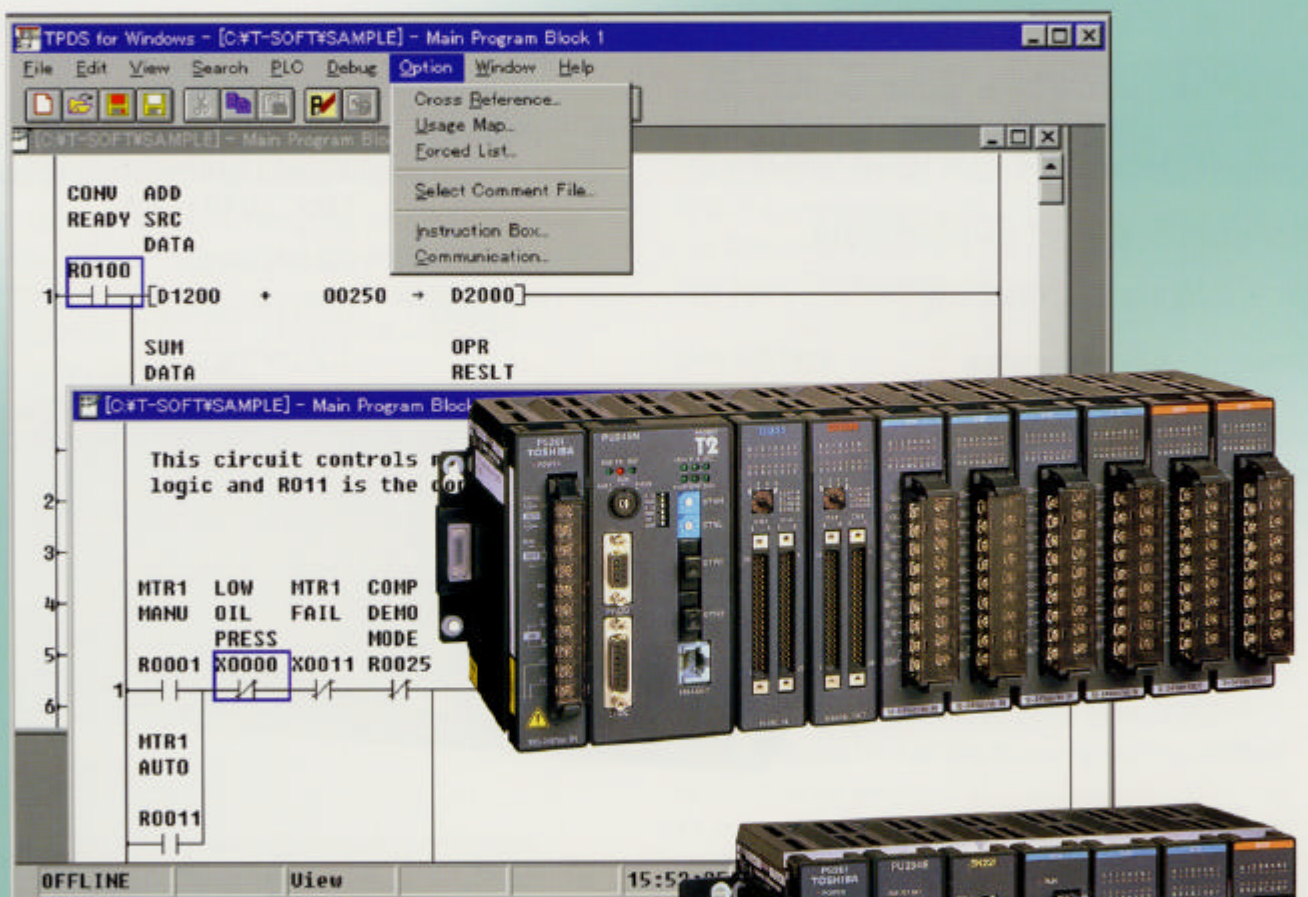

## Advanced Features

- Floating-Point Math
- Large Program & Data Memory
- Ethernet/DeviceNet Networks
- Active Serial ASCII Port
- Two Programming Languages
- MS Windows Programming Software

# PROSEC T2E/T2N

## Small, Powerful Modular Style Programmable Controllers

Toshiba's T2E/T2N are small, modular type programmable controller suitable for both relay replacement and complex control applications. The T2E/T2N are 2nd generation T2 CPUs. The T2E/T2N provide a functional, economical, and compact solution to a wide range of OEM and user applications in automotive, machine control, and process control systems.

### T2N

Local I/O: Max. 2048 points  
Program: 23.5 k steps  
Speed: 0.33  $\mu$ s/contact  
1.2  $\mu$ s/transfer



### T2E

Local I/O: Max. 1024 points  
Program: 9.5 k steps  
Speed: 0.33  $\mu$ s/contact  
1.2  $\mu$ s/transfer

# Key Features

## High speed processing

The T2E/T2N excels at applications where high speed processing is required.

- 0.33  $\mu$ s/contact
- 0.44  $\mu$ s/coil
- 1.2  $\mu$ s/16-bit transfer
- 1.63  $\mu$ s/16-bit addition

## Advanced instruction set

The T2E/T2N offers 24 basic relay-ladder instructions and 192 function block instructions, including the following.

- Arithmetic operation
- Data manipulations
- Trigonometric functions
- PID/ramp/integral
- Subroutine call
- For-Next loop
- Averaging/filtering
- ASCII  $\leftrightarrow$  Hex conversion
- Floating-point math

## Two programming Languages

The T2E/T2N supports two programming languages: Ladder Diagram (LD) and Sequential Function Chart (SFC). By selecting the appropriate language, or combination of the two, program development time can be greatly reduced.

## Built-in clock/calendar

The T2E/T2N has a real-time-clock/calendar function (year, month, day, week, hours, minutes, seconds) that can be used for performing scheduled operations, data gathering with time stamps, etc.

## Password protection

The T2E/T2N can be programmed with one of four selectable protection levels.

- Level 1: No protect (normal)
- Level 2: Writing/modifying program prohibited
- Level 3: Level 2 plus viewing program prohibited
- Level 4: Level 3 plus writing data prohibited

## Battery-less operation (T2E)

The user-program is saved in a built-in Flash memory. No battery maintenance is required.

## Ethernet connection (T2N)

The T2N CPU modules (PU235N and PU245N) have built-in Ethernet interface (10BASE-T). Through the Ethernet, the T2N can communicate with higher level controllers (computer, workstation, etc.) or other PLCs with Ethernet.

## High speed industrial LAN

The T2E/T2N can be connected to Toshiba's high speed industrial LANs (Local Area Networks) TOSLINE-S20 and TOSLINE-F10. The TOSLINE series are suited for real-time control data linkage. Through these networks, the T2E/T2N can exchange data with other Toshiba equipment, such as the TOSDIC CIE system, other T-series PLCs, Large Adjustable Speed Drives, General Purpose Inverters, etc.

The T2N CPU module PU245N has the TOSLINE-S20LP (Loop version) built-in into the CPU module. The TOSLINE-S20LP is a high-reliability double-loop fiber optic S20 network.

## DeviceNet

A DeviceNet scanner module is available for the T2E/T2N. The DeviceNet scanner module can read/write data to any other manufacturer's ODVA certified devices (I/O blocks, Inverters to include Toshiba's G3, air valve manifolds, sensors, etc.).

## Flexible serial port

The T2E/T2N has RS-232C or RS-485 serial communication port. (It is optional in the T2E) Using this port, one of the following communication modes can be selected.

- Computer link mode: Connection with higher level computer, MMI/SCADA system, modem, etc.
- Data link mode: Easy data linkage between two T2Es, T2Ns, T2E—T2N or T2E/T2N—Super T1.
- Free ASCII mode: Active communication between serial ASCII devices. (bar code readers, etc.)

## Programmer port function

The T2E/T2N's RS-232C programmer port supports the T-series computer link protocol. This allows easy connection to a higher level computer, an operator interface unit, a modem, etc.

# System Configuration

## T2E CPU Unit Configuration

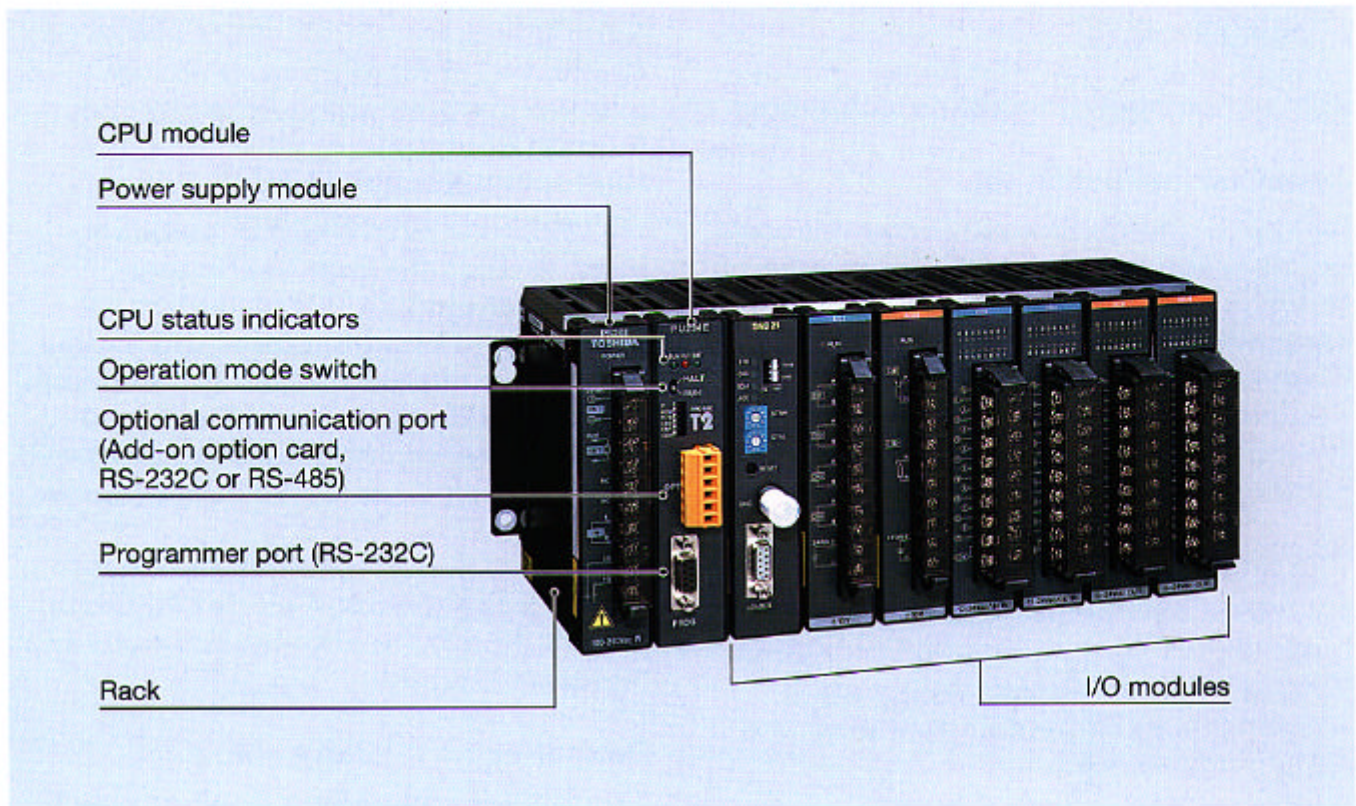

### T2E basic components

Item	Type	Description
CPU module	PU234E	9.5 k steps, clock/calendar
CPU add-on option card	CM231E	RS-485 port, w/ battery
	CM232E	RS-232C port, w/ battery
	BT231E	Battery card
Power supply module	PS261	100 to 240 Vac
	PS31	24 Vdc

Item	Type	Description
CPU rack	BU218	8 I/O slots, expandable
	UBB2	7 I/O slots, expandable
	UBB1	4 I/O slots, expandable
	UBA2	7 I/O slots, non expandable
	UBA1	4 I/O slots, non expandable
Expansion rack	BU268	8 I/O slots
	BU266	6 I/O slots

- The CM231E and the CM232E are optional communication cards for T2E. These cards also have the optional battery mounted on them.
- The CM231E has a terminal block for RS-485 interface. The CM232E has a D-Sub 9-pin (female) connector for RS-232C interface.
- The BT231E is a card that has only the optional battery.
- The T2E CPU module can hold only one option card; CM231E, CM232E or BT231E.
- The UBA1 and the UBA2 are stand-alone CPU racks, expansion racks can not be connected.
- The UBB1 and the UBB2 can be used as either CPU or expansion racks. When the UBB1 or UBB2 is used as expansion rack, only one expansion rack can be connected.
- The BU266 and the BU268 can be used as either CPU or expansion racks. When the BU266 is used as CPU rack, it has 5 I/O slots. When the BU268 is used as CPU rack, it has 7 I/O slots.

## T2N CPU Unit Configuration

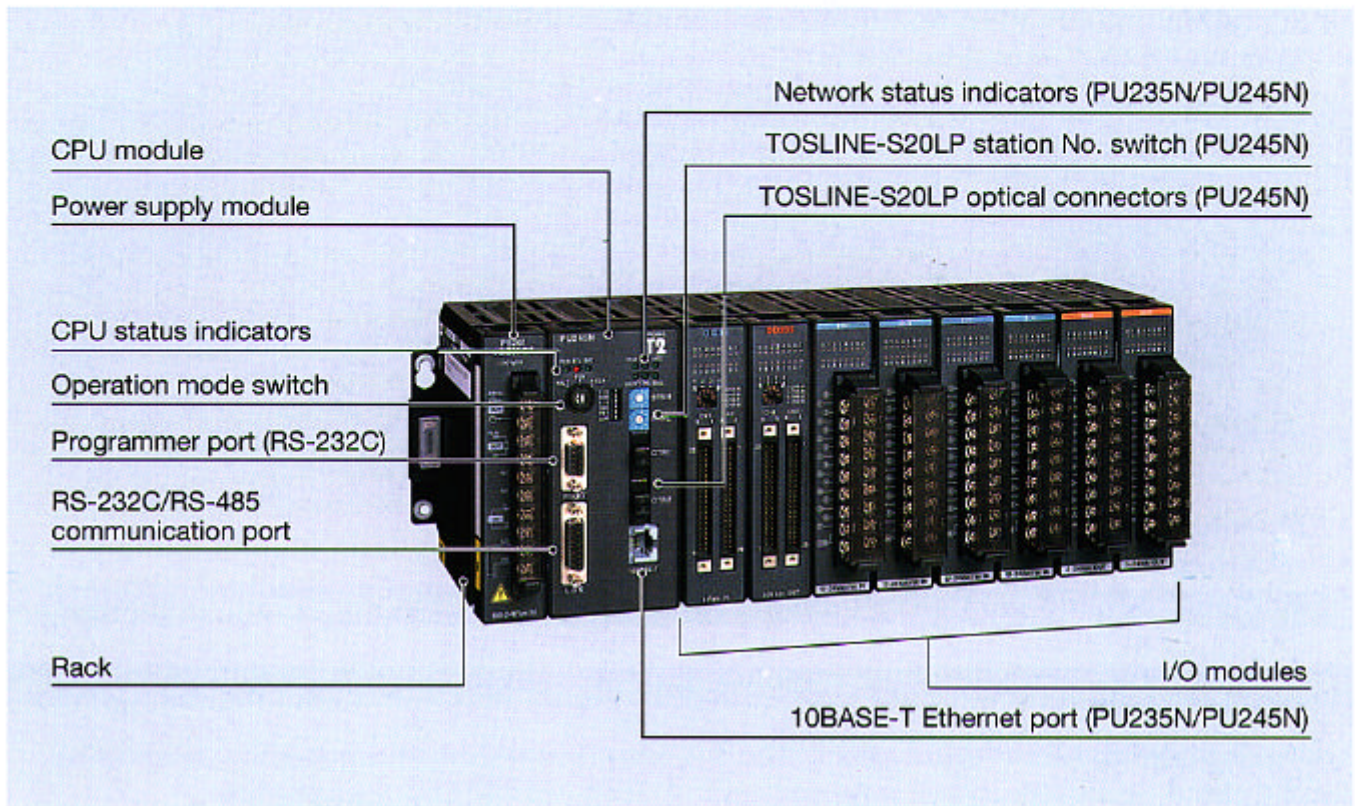

### T2N basic components

Item	Type	Description
CPU module	PU215N	23.5 k steps, standard type
	PU235N	Standard plus Ethernet
	PU245N	Standard plus Ethernet and TOSLINE-S20LP

Item	Type	Description
Power supply module	PS261	100 to 240 Vac
	PS31	24 Vdc
CPU rack	BU228N	8 I/O slots
Expansion rack	BU268	8 I/O slots
	BU266	6 I/O slots

- The RS-232C/RS-485 communication port (D-Sub 15-pin female connector) is built-in the T2N CPU module. The interface, RS-232C or RS-485, is selected by the switch provided on the CPU module. This port has the same function as the optional communication cards (CM231E or CM232E) on the T2E CPU.
- The PU235N has all the PU215N functions plus Ethernet (10BASE-T) interface.
- The PU245N has all the PU215N functions plus Ethernet (10BASE-T) interface and the TOSLINE-S20LP interface.
- Each T2N CPU module comes with a battery.
- The T2N CPU module can be mounted only in the BU228N rack.
- The BU266 and the BU268 can be used only for the expansion racks with the T2N.

## Expansion Configuration

Up to three expansion racks (BU266 or BU268) can be connected to the T2E/T2N CPU rack. In the maximum configuration, the T2E/T2N provides 32 slots for I/O modules.

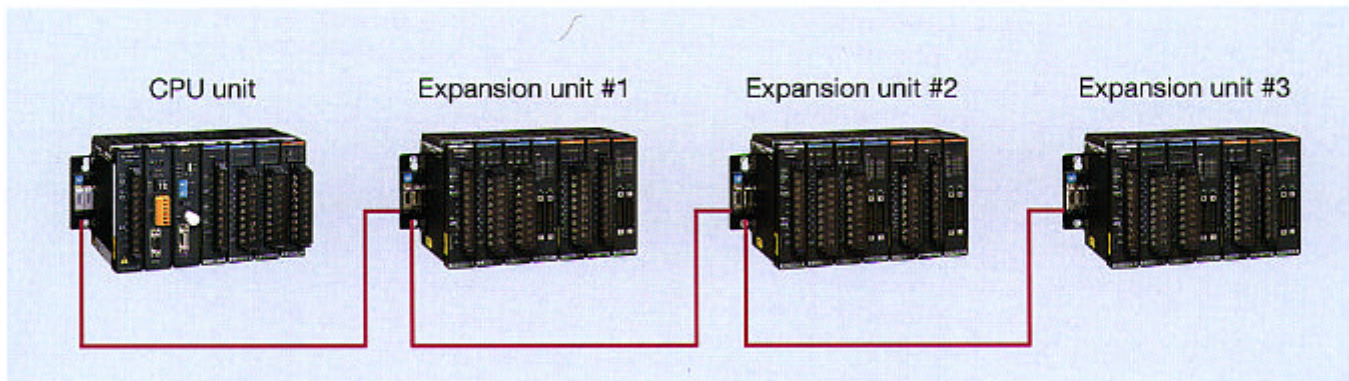

- A power supply module is necessary in each rack.
- The following expansion cables are available; 30 cm, 50 cm, 70 cm and 1.5 m.
- The total cable length cannot exceed 4.5 m.

## Power Supply Check

The power supply module can output maximum 2.5 A (5 Vdc) to power the internal logic of the modules. Check that the internal current consumption of the modules on a rack is less than the 2.5 A maximum.

The list below shows the internal current consumption of each module.

Item	Type	Internal 5 Vdc consumption
T2E CPU	PU234E	600 mA or less
T2E optional communication card	CM231E	200 mA or less
	CM232E	200 mA or less
T2N CPU	PU215N	800 mA or less
	PU235N	1.5 A or less
	PU245N	2.0 A or less
CPU rack for T2E	BU218	50 mA or less
	UBB2	50 mA or less
	UBB1	50 mA or less
	UBA2	50 mA or less
	UBA1	50 mA or less
CPU rack for T2N	BU228N	50 mA or less
Expansion rack	BU268	50 mA or less
	BU266	50 mA or less
16 points DC input	DI31	15 mA or less
32 points DC input	DI32	80 mA or less
64 points DC input	DI235	100 mA or less
16 points AC input	IN51	15 mA or less
	IN61	15 mA or less
12 points relay output	RO61	50 mA or less

Item	Type	Internal 5 Vdc consumption
8 points relay output	RO62	40 mA or less
16 points transistor output	DO31	60 mA or less
	DO233P	60 mA or less
32 points transistor output	DO32	250 mA or less
64 points transistor output	DO235	250 mA or less
12 points triac output	AC61	300 mA or less
4 channels analog input	AI21	50 mA or less
	AI31	50 mA or less
	AI22	50 mA or less
	AI32	50 mA or less
2 channels analog output	AO31	70 mA or less
	AO22	170 mA or less
	AO32	170 mA or less
1 channel pulse input	PI21	80 mA or less
1 axis position control	MC11	200 mA or less
Communication interface	CF211	550 mA or less
TOSLINE-S20 (coaxial)	SN221	600 mA or less
TOSLINE-S20 (optical)	SN222A	700 mA or less
TOSLINE-F10 (master)	MS211	600 mA or less
TOSLINE-F10 (remote)	RS211	600 mA or less
DeviceNet scanner	DN211	500 mA or less

# Flexible Serial Port

## Programmer Port

The T2E/T2N's RS-232C programmer port supports the open T-series computer link protocol as well as the proprietary programmer protocol. This provides an easy connection to a higher level computer, an operator interface unit, a modem, etc.

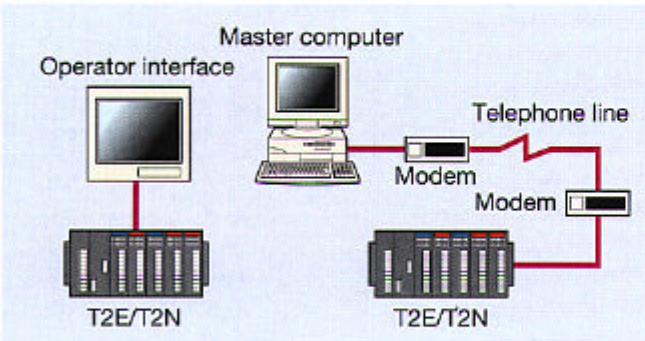

Interface	RS-232C
Transmission system	Half-duplex
Transmission speed	9600 bps
Framing	Start bit: 1 bit Data bits: 8 bits Parity: Odd or none Stop bit: 1 bit
Protocol	Computer link protocol, Programmer protocol

## Communication Port on the CPU Module

The RS-232C or RS-485 multi-purpose communication port is standard on the T2N CPU. The interface is selected by a DIP switch.

The RS-232C or RS-485 multi-purpose communication port is an option on the T2E CPU. A CM231E or CM232E card must be mounted in the T2E CPU module.

By using these communication port, one of the following three communication modes is available.

### Computer link mode

T-series computer link protocol can be used in this mode. When the RS-485 is used, a maximum of 32 T2E/T2Ns can be connected to a master computer.

By using this mode, all the T2E/T2N's data can be accessed by a master computer.

The T-series PLC programming software (T-PDS) can also be used in this configuration.

Transmission system	Half-duplex
Transmission speed	300/600/1200/2400/ 4800/9600/19200 bps
Framing	Start bit: 1 bit Data bits: 7 or 8 bits Parity: Odd/even/none Stop bit: 1 or 2 bits
Protocol	Computer link protocol, Programmer protocol

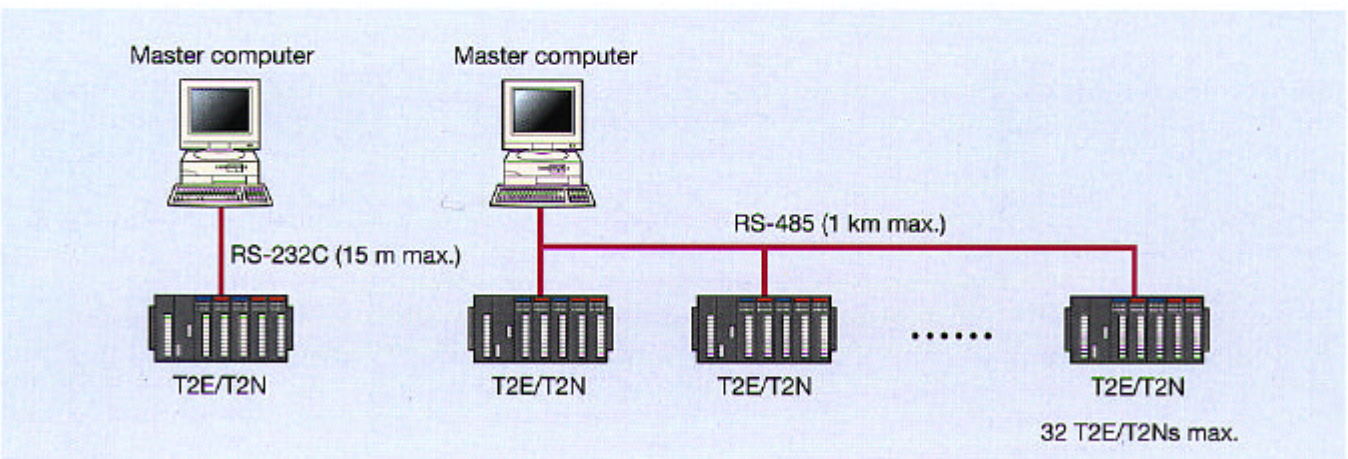

## Communication Port on the CPU Module

### Free ASCII mode

User defined ASCII messages can be transmitted and received through this port. A terminal, printer, bar-code reader, or other serial ASCII device can be directly connected.

This mode allows the T2E/T2N to communicate with other PLCs (T1, T2E, T2N, etc.), Inverters (such as VF-S7/A5, G3), or Motor protection relays (S2E21).

Transmission system	Half-duplex
Transmission code	ASCII
Transmission speed	300/600/1200/2400/ 4800/9600/19200 bps
Framing	Start bit: 1 bit Data bits: 7 or 8 bits Parity: Odd/even/none Stop bit: 1 or 2 bits
Message length	512 bytes max.

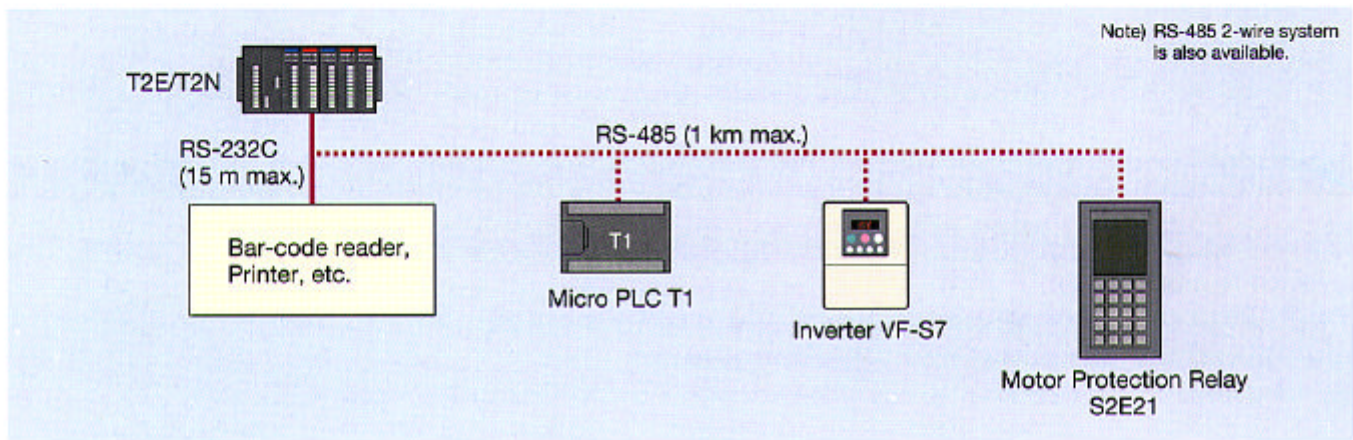

### Data link mode

Two PLCs (any combination of T2E, T2N or Super T1-40) can be directly linked together. This direct link is inexpensive, easily configured and requires no special programming. File registers F0000 to F0031 are used for the data transfer.

Transmission speed	19200 bps
Protocol	Special
Link data capacity	16 words (station 1 to 2) 16 words (station 2 to 1)
Link data update time	approx. 50 ms (not synchronized with T2E/T2N's scan)

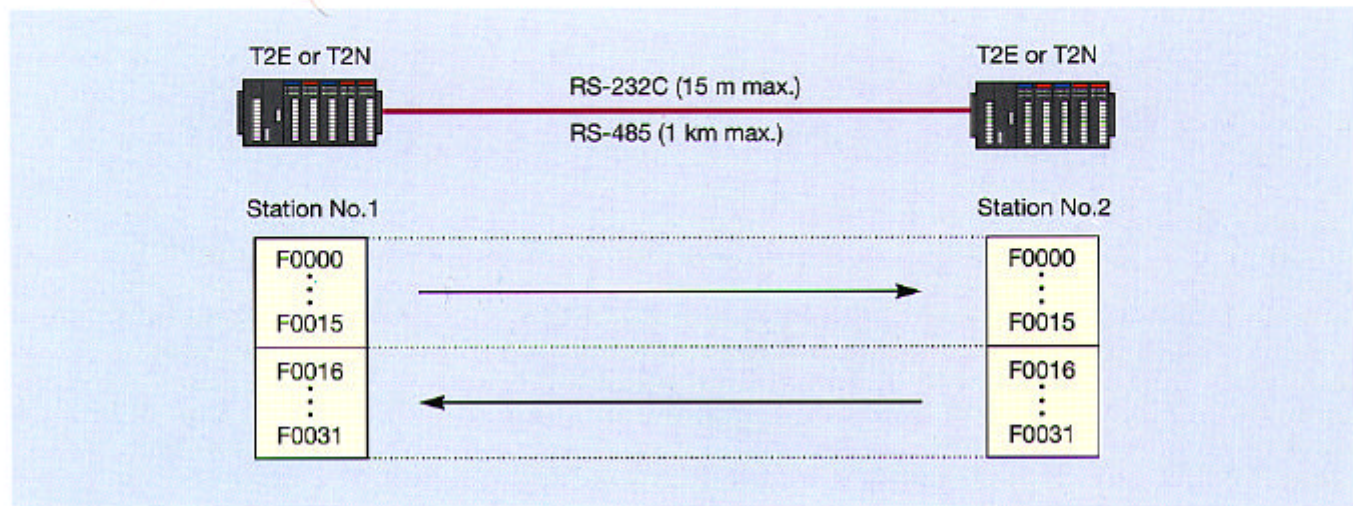

# Networks

## Network Configuration

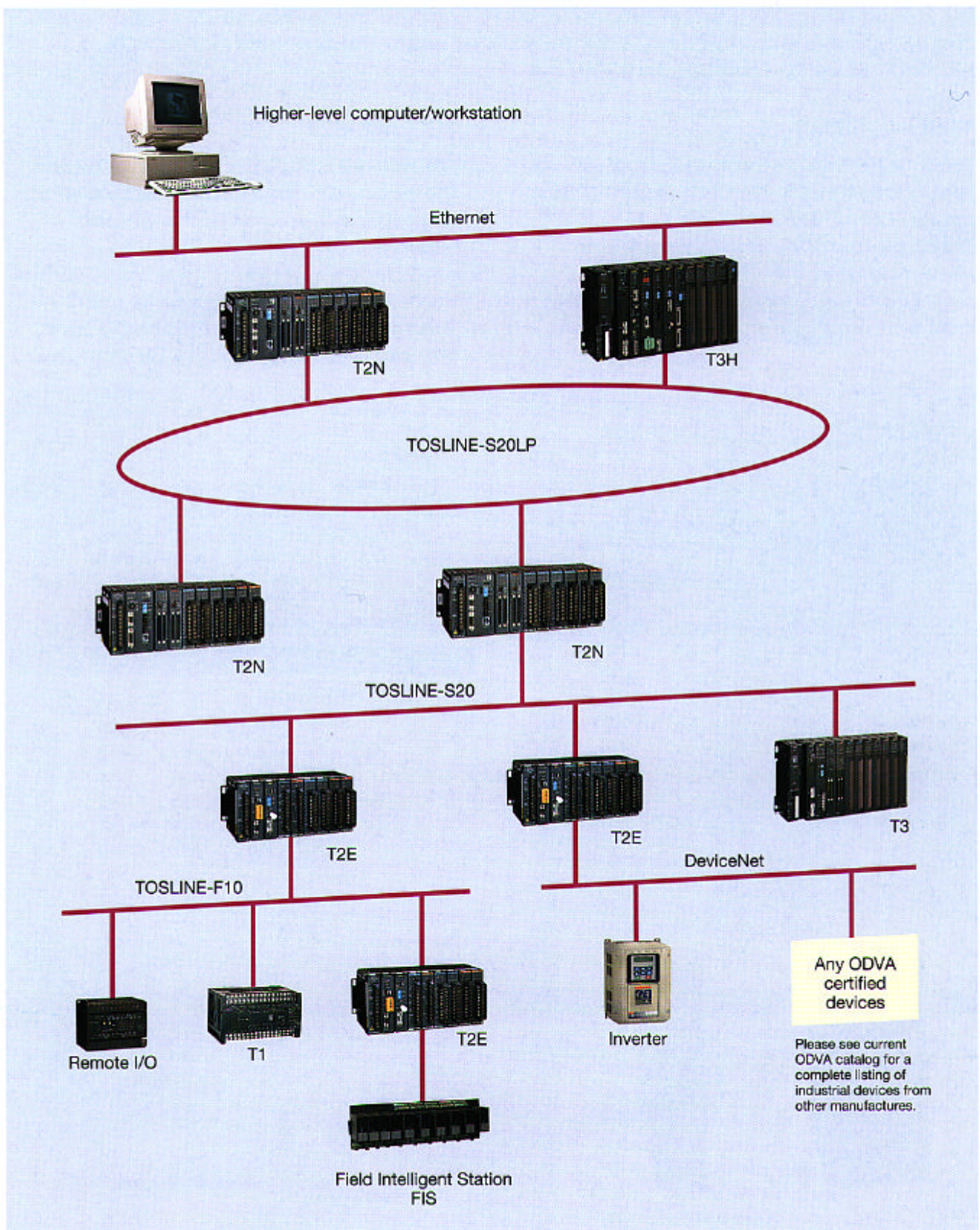

## TOSLINE-S20/S20LP

The TOSLINE-S20/S20LP is an N-to-N high-speed data link network. Implicit token passing avoids the possibility of message collision. The TOSLINE-S20/S20LP is ideal for real-time control between PLCs, or between PLCs and Toshiba Adjustable Speed Drives.

### TOSLINE-S20LP

The TOSLINE-S20LP is a high-reliability double-loop fiber optic system. The T2N CPU module (PU245N) has the TOSLINE-S20LP built-in.

The double-loop configuration and the floating master function allow the TOSLINE-S20LP to continue data link operation even if a transmission cable is cut or a station drops out of the network.

### TOSLINE-S20

The TOSLINE-S20 is a bus type data link network. The transmission media can be either co-axial or fiber optic cable, according to the application requirement.

- SN221: Co-axial cable type station for T2E/T2N
  - SN222A: Fiber optic type station for T2E/T2N
- These station modules can be mounted in any I/O slot, main or expansion rack, of a T2E/T2N system.

Item	TOSLINE-S20LP	TOSLINE-S20
Topology	Double loop	Bus
Access method	Implicit token passing	
Transmission speed	2 Mbps	
Transmission cable	Fiber optic cable (H-PCF 200/230 $\mu\text{m}$ )	Coaxial cable (5C2V) or Fiber optic cable (GI 50/125 $\mu\text{m}$ )
Max. transmission distance	Fiber optic: 1 km (between stations) System total: 30 km	Coaxial cable: 1 km (cable total) Fiber optic: 1 km (between stations) System total: 10 km
Max. number of stations	64 stations	
Communication service	Scan transmission Message transmission	
Scan transmission capacity	4096 words	1024 words
Scan data update time	61.4 ms/4096 words	25 ms/1024 words
Transmission error check	CRC	
Parameter setting tool	TOSLINE-S20/S20LP Loader System (S-LS) (software runs on Windows 95)	
Connectable device	PLC (T3H and T2N), Process control station (PCS), Industrial computer	PLC (T3H, T3, T2N, T2E and T2), Process control station (PCS), Industrial computer, Plant drive ( $\mu$ /S series), Inverter (VF-A5, G3)



Note) In the T2N, the TOSLINE-S20 is accessed by READ and WRITE instructions.

### Remote Programming/monitoring through TOSLINE-S20/S20LP

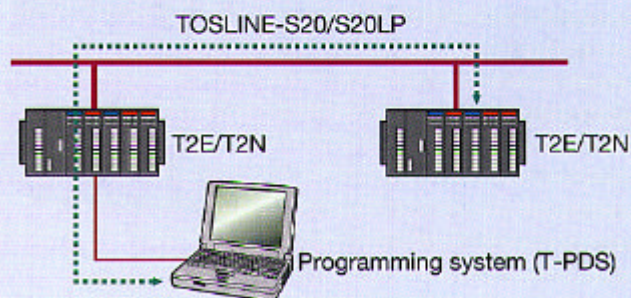

## Ethernet

The T2N CPU modules (PU235N and PU245N) have a built-in Ethernet interface (10BASE-T). Through Ethernet, the T2N can communicate with a computer, a workstation, or another T2N.

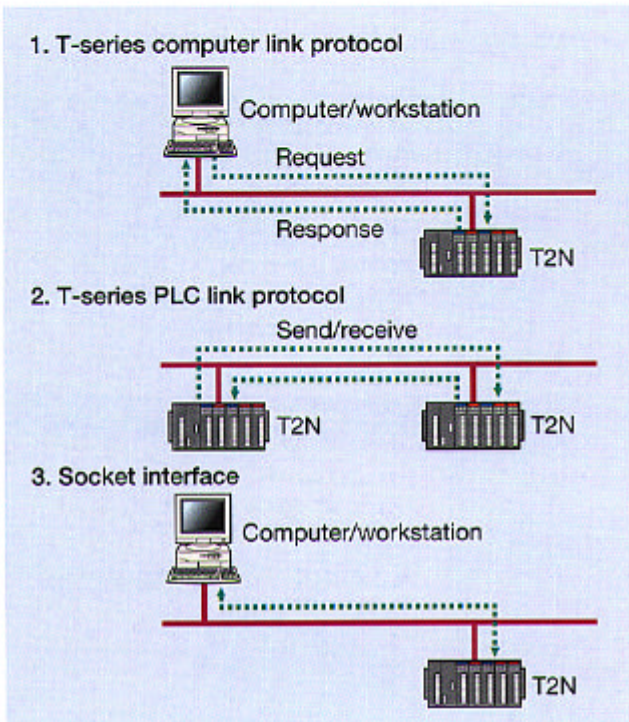

Item	PU235N / PU245N
Interface	10BASE-T
Media access method	CSMA/CD
Modulation method	Base-band
Topology	Bus
Transmission speed	10 M bps
Distance between nodes	200 m max. (with 1 HUB) 1700 m max. (with 4 HUBs)
Segment length	100 m max. (Node to HUB)
Connector	8-pin modular (RJ-45)
Cable	Twisted-pair (26 to 22 AWG)
Communication service	Computer link protocol T-series PLC link protocol Socket interface (8 ports)

Note) The Ethernet interface is controlled by T2N's SEND and RECV instructions.

## DeviceNet

DeviceNet is an open standard field network. Many DeviceNet compatible products (ODVA certified) are available from other manufactures.

The DN211 is a DeviceNet scanner module for the T2E/T2N. The DN211 can read/write data to any other manufacturer's ODVA certified devices, such as I/O blocks, Inverters including Toshiba's G3, air valve manifolds, sensors, etc.



Note) The DN211 is accessed by T2E/T2N's READ and WRITE instructions.

Item	DN211			
Topology	Bus			
Number of slaves	63 max.			
Transmission speed	125 k, 250 k, or 500 k bps			
Media access method	CSMA/NBA			
Modulation method	Base-band			
Transmission distance (Trunk line)	125 k	250 k	500 k	
	Thick	500 m	250 m	100 m
	Thin	100 m	100 m	100 m
Max. drop length	6 m	6 m	6 m	
Max. total drop length	156 m	78 m	39 m	
Scan I/O capacity	Input: 128 words/2048 pts Output: 128 words/2048 pts			
Function	Slave parameter setting from T2E/T2N <ul style="list-style-type: none"> <li>• Bit strobe</li> <li>• Polling</li> <li>• Change of state/cyclic</li> </ul>			
Number of DN211 on a T2E/T2N	Limited only by power capacity			

## TOSLINE-F10

The TOSLINE-F10 is a field network suitable for small distributed I/O systems. Data link between T-series PLCs is also available. The TOSLINE-F10 is extremely easy to setup compared to other field networks.

For the T2E/T2N, two types of TOSLINE-F10 station modules are available.

- MS211: Master station for T2E/T2N
- RS211: Remote station for T2E/T2N

These station modules can be mounted in any I/O slot, main or expansion rack, of a T2E/T2N system.



Item	TOSLINE-F10
Topology	Bus
Access method	Poling/selecting
Transmission speed	750 kbps or 250 kbps (selectable)
Transmission cable	Twisted pair cable (1.2 mm <sup>2</sup> )
Max. transmission distance	750 kbps: 0.5 km (total) 250 kbps: 1 km (total)
Max. number of stations	32 stations
Communication service	Scan transmission
Scan transmission capacity	32 words
Scan data update time	7 ms/32 words (750 kbps) 12 ms/32 words (250 kbps)
Transmission error check	CRC
Connectable device	PLC (T3H/T3, T2N/T2E/T2 and T1), Remote I/O block, Inverter (VF-A5, G3)

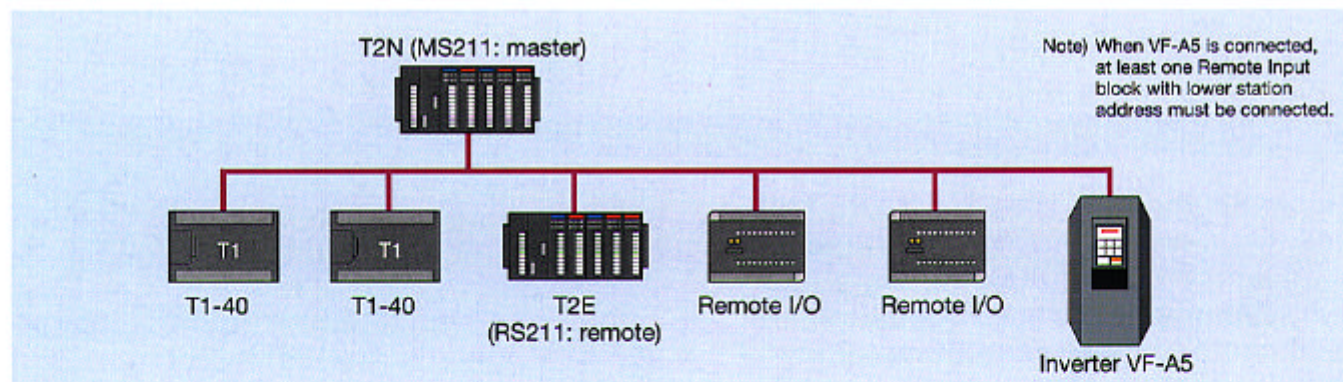

### Remote I/O Block Specifications

Item	DI633
Module type	DC input (Dry contact input)
Input voltage	24 Vdc, +10/-15%
Min. ON voltage	9.6 V
Max. OFF voltage	3.5 V
Input current	10 mA (at 24 Vdc)
Input points	16 points (16/common)
ON delay	10 ms or less
OFF delay	15 ms or less
Power voltage	24 Vdc, +10/-15%

Item	RO663	DO633
Module type	Relay output	DC output
Output voltage	24 Vdc, +20% / 240 Vac, +10% (max.)	12 to 24 Vdc, +10/-20%
Load current	2 A/point (resistive) 4 A/common	1 A/point, 4 A/common
Output points	16 points (4 x 4/common)	16 points (16/common)
ON delay	10 ms or less	1 ms or less
OFF delay	10 ms or less	1 ms or less
Power voltage	24 Vdc, +10/-15%	

# Programming Tools

## T-series Compatible

The HP911 Handy Programmer and the T-PDS (T-series Program Development System) software program the entire family of T-series programmable controllers. Programming instructions are upward compatible in the T-series controllers.



## Handy Programmer

The HP911 is a hand-held graphic programmer. Its portability makes it ideal for maintenance use at remote locations. The HP911 has all the features of a full size programming terminal. (2 m cable for connecting T2E/T2N is included)



- Ladder logic programming of T-series programmable controllers T1, T2, T2E, T2N and T3.  
(SFC programming/monitoring is not possible)
- Built-in EEPROM allows program copy between T-series controllers.
- Two display modes,
  - Normal: 5 lines and 12 columns
  - Zoom: Full device description
- Data monitor for I/O and internal registers.
- On-line data set & I/O force.
- Backlit LCD display for better operation in dim light.

## Program Storage Module RM102



The RM102 is an external memory, which can store a T2E or a T2N program. By using the RM102, program saving from the T2E/T2N to the RM102, and program loading from the RM102 to the T2E/T2N can be done without need of a programmer.

Because the RM102 has an EEPROM, maintenance-free program storage and rapid saving/loading can be done.

Note) To connect the RM102 to the T2E/T2N, an adapter is necessary.



# Instruction Set

## Basic Instructions

FUN No.	Symbol	Name
	-   -	NO contact
	- / -	NC contact
	-↑ -	Transitional contact (rising edge)
	-↓ -	Transitional contact (falling edge)
	-( )-	Coil
	*-( )-	Forced coil (debugging purpose only)
	-   -	Inverter
	-( )-	Invert coil
	- P -	Positive pulse contact
	- N -	Negative pulse contact
	-(P)-	Positive pulse coil
	-(N)-	Negative pulse coil
	JCS	Jump control set
	JCR	Jump control reset
	TON	ON delay timer
	TOF	OFF delay timer
	SS	Single-shot timer
	CNT	Counter
	MCS	Master control set
	MCR	Master control reset
134	MCSn	Master control set (nesting)
135	MCRn	Master control reset (nesting)
148	TRG	Timer trigger
	END	End

## Data transfer Instructions

FUN No.	Symbol	Name
18	MOV	Data transfer
19	DMOV	Double-word data transfer
20	NOT	Invert transfer
21	DNOT	Double-word invert transfer
22	XCHG	Exchange
23	DXCH	Double-word exchange
24	TINZ	Table initialize
25	TMOV	Table block transfer
26	TNOT	Table invert transfer
90	MPX	Multiplexer
91	DPX	Demultiplexer
92	TBM	Table → bit transfer
93	BTM	Bit → table transfer

## Arithmetic Operations

FUN No.	Symbol	Name
27	+	Addition
28	-	Subtraction
29	*	Multiplication
30	/	Division
31	D+	Double-word addition
32	D-	Double-word subtraction
33	D*	Double-word multiplication
34	D/	Double-word division
35	+C	Addition with carry
36	-C	Subtraction with carry
37	D+C	Double-word addition with carry
38	D-C	Double-word subtraction with carry
39	U*	Unsigned multiplication
40	U/	Unsigned division
41	DIV	Unsigned double/single division
43	+1	Increment
44	D+1	Double-word increment
45	-1	Decrement
46	D-1	Double-word decrement

## Logical Operations

FUN No.	Symbol	Name
48	AND	AND
49	DAND	Double-word AND
50	OR	OR
51	DOR	Double-word OR
52	EOR	Exclusive OR
53	DEOR	Double-word exclusive OR
54	ENR	NOT exclusive OR
55	DENR	Double-word NOT exclusive OR
57	TAND	Table AND
58	TOR	Table OR
59	TEOR	Table exclusive OR
60	TENR	Table NOT exclusive OR
64	TEST	Bit test
65	DTST	Double-word bit test
66	TTST	Bit file bit test

## Shift Instructions

FUN No.	Symbol	Name
68	SHR1	1 bit shift right
69	SHL1	1 bit shift left
70	SHRn	n bits shift right
71	SHLn	n bits shift left
72	TSHR	Bit file n bits shift right
73	TSHL	Bit file n bits shift left
74	SR	Shift register
75	DSR	Bi-directional shift register
76	SFT	Device shift

## Rotate Instructions

FUN No.	Symbol	Name
78	RTR1	1 bit rotate right
79	RTL1	1 bit rotate left
80	RTRn	n bits rotate right
81	RTLn	n bits rotate left
82	TRTR	Bit file n bits rotate right
83	TRTL	Bit file n bits rotate left
84	RRC1	1 bit rotate right with carry
85	RLC1	1 bit rotate left with carry
86	RRCn	n bits rotate right with carry
87	RLCn	n bits rotate left with carry
88	TRRC	Bit file n bits rotate right with carry
89	TRLC	Bit file n bits rotate left with carry

## Comparison Instructions

FUN No.	Symbol	Name
95	TCMP	Bit file comparison
96	>	Greater than
97	>=	Greater than or equal
98	=	Equal
99	<>	Not equal
100	<	Less than
101	<=	Less than or equal
102	D>	Double-word greater than
103	D>=	Double-word greater than or equal
104	D=	Double-word equal
105	D<>	Double-word not equal
106	D<	Double-word less than
107	D<=	Double-word less than or equal
108	U>	Unsigned greater than
109	U>=	Unsigned greater than or equal
110	U=	Unsigned equal
111	U<>	Unsigned not equal
112	U<	Unsigned less than
113	U<=	Unsigned less than or equal

## Special Data Operations

FUN No.	Symbol	Name
114	SET	Device / register set
115	RST	Device / register reset
116	TSET	Table bit set
117	TRST	Table bit reset
118	SETC	Set carry
119	RSTC	Reset carry

## Special Data Operations

FUN No.	Symbol	Name
120	ENC	Encode
121	DEC	Decode
122	BC	Bit count
123	DBC	Double-word bit count
124	SCH	Data search
125	PUSH	Push
126	POPL	Pop last
127	POPF	Pop first
147	F/F	Flip flop
149	U/D	Up / down counter

## Program Control Instructions

FUN No.	Symbol	Name
128	CALL	Subroutine call
137	SUBR	Subroutine entry
129	RET	Subroutine return
130	JUMP	Conditional jump
136	LBL	Jump label
132	FOR	FOR-NEXT loop (FOR)
133	NEXT	FOR-NEXT loop (NEXT)
138	STOP	Program execution stop
140	EI	Enable interrupt
141	DI	Disable interrupt
142	IRET	Interrupt return
143	WDT	Watchdog timer reset
144	STIZ	Step sequence initialization
145	STIN	Step sequence input
146	STOT	Step sequence output
158	DRUM	Drum sequencer
159	CAM	Cam sequencer
241	SFIZ	SFC initialization

## RAS Functions

FUN No.	Symbol	Name
150	DIAG	Diagnostic display
151	DIAR	Diagnostic display reset
152	STLS	Status latch set
153	STLR	Status latch reset
154	CLND	Calendar set
155	CLDS	Calendar operation

## Functions

FUN No.	Symbol	Name
56	MAVE	Moving average
61	DFL	Digital filter
160	UL	Upper limit
161	LL	Lower limit
162	MAX	Maximum value
163	MIN	Minimum value
164	AVE	Average value
165	FG	Function generator
166	DB	Dead band
167	RT	Square root
168	INTG	Integral
169	RAMP	Ramp function
170	PID	PID (proportional integral derivative)
171	PID2	Deviation square PID
156	PID3	Pre-derivative real PID
172	SIN	Sine function
173	COS	Cosine function
174	TAN	Tangent function
175	ASIN	Arc-sine function
176	ACOS	Arc-cosine function
177	ATAN	Arc-tangent function
178	EXP	Exponential function
179	LOG	Logarithm

## Data Conversion Instructions

FUN No.	Symbol	Name
62	HTOA	HEX to ASCII conversion
63	ATOH	ASCII to HEX conversion
180	ABS	Absolute value
181	DABS	Double-word absolute value
182	NEG	Two's complement
183	DNEG	Double-word two's complement
184	DW	Double-word conversion
185	7SEG	7-segment decode
186	ASC	ASCII conversion
188	BIN	BCD to binary conversion
189	DBIN	Double-word BCD to binary conversion
190	BCD	Binary to BCD conversion
191	DBCD	Double-word binary to BCD conversion

## BCD Operations

FUN No.	Symbol	Name
192	B+	BCD addition
193	B-	BCD subtraction
194	B*	BCD multiplication
195	B/	BCD division
196	DB+	Double-word BCD addition
197	DB-	Double-word BCD subtraction
198	DB*	Double-word BCD multiplication
199	DB/	Double-word BCD division
200	B+C	BCD addition with carry
201	B-C	BCD subtraction with carry
202	DB+C	Double-word BCD addition with carry
203	DB-C	Double-word BCD subtraction with carry

## Floating-Point Instructions

FUN No.	Symbol	Name
204	FLT	Fixed-point to floating-point conversion
205	FIX	Floating-point to fixed-point conversion
208	F+	Floating-point addition
209	F-	Floating-point subtraction
210	F*	Floating-point multiplication
211	F/	Floating-point division
212	F>	Floating-point greater than
213	F>=	Floating-point greater than or equal
214	F=	Floating-point equal
215	F<>	Floating-point not equal
216	F<	Floating-point less than
217	F<=	Floating-point less than or equal

## Special I/O Instructions

FUN No.	Symbol	Name
235	I/O	Direct input / output
236	XFER	Expanded data transfer
237	READ	Special module data read
238	WRITE	Special module data write
239	SEND	Network data send
240	RECV	Network data receive

# Specifications

## Functional Specifications

Item		T2E	T2N
Control method		Stored program, cyclic scan system	
Scanning system		Floating scan or constant scan (interval: 10 to 200 ms, 10 ms units)	
I/O processing method		Batch I/O (refresh), Direct I/O, or combination	
Number of I/O points (local)		1024 points/64 words	2048 points/128 words
User program	Program language	Ladder diagram (relay symbol + function block) Sequential Function Chart (SFC)	
	Program capacity	9.5 k steps	23.5 k steps
	Memory	SRAM and Flash memory	
	Instructions	Basic ladder instructions: 24 types Function instructions: 192 types	
	Execution speed	0.33 $\mu$ s/contact, 0.44 $\mu$ s/coil, 1.2 $\mu$ s/transfer, 1.63 $\mu$ s/addition	
Program types		1 main program 1 sub-program (initial program) 1 timer interrupt (interval: 5 to 1000 ms, 5 ms units) 256 subroutines	
User data	I/O device/register	1024 points/64 words (X/Y or XW/YW: batch I/O, I/O or IW/OW: direct I/O)	2048 points/128 words (X/Y or XW/YW: batch I/O, I/O or IW/OW: direct I/O)
	Auxiliary device/register	2048 points/128 words (R/RW)	4096 points/256 words (R/RW)
	Special device/register	4096 points/256 words (S/SW)	
	Timer device/register	256 points (T./T) (T000—T063: 10 ms) (T064—T255: 100 ms)	512 points (T./T) (T000—T063: 10 ms) (T064—T511: 100 ms)
	Counter device/register	256 points (C./C)	512 points (C./C)
	Data register	4096 words (D)	8192 words (D)
	Link device/register	8192 points/1024 words (Z/W) (for TOSLINE-S20)	16000 points/2048 words (Z/W) (for TOSLINE-S20LP)
	Link relay/register	4096 points/256 words (L/LW) (for TOSLINE-F10)	
	File register	1024 words (F)	
	Expanded file register	24576 words (accessed by XFER instruction)	
	Index register	I, J, K (total 3 words)	
Retentive memory	User specified range for RW, T, C and D, and whole F		
Clock/calendar		Year, month, day, day of the week, hour, minute, second	
SRAM memory back-up		Super capacitor: 3 days/25 °C Battery (option): 5 years/25 °C	Battery (built-in): 5 years/25 °C
Serial communication function		Programmer port: (RS-232C): <ul style="list-style-type: none"> <li>• T-series programmer protocol (1-to-1)</li> <li>• T-series computer link protocol (1-to-1)</li> </ul> Communication port: (RS-485 or RS-232C) (using optional comms card in case of T2E) <ul style="list-style-type: none"> <li>• T-series programmer protocol (1-to-N)</li> <li>• T-series computer link protocol (1-to-N)</li> <li>• Free ASCII communication</li> <li>• 32 words data link (between two T2E/T2Ns)</li> </ul>	
Networks		TOSLINE-S20 TOSLINE-F10 DeviceNet	Ethernet (10BASE-T) TOSLINE-S20LP TOSLINE-S20 TOSLINE-F10 DeviceNet
RAS	Diagnosis	Battery level, I/O bus check, I/O response, I/O registration, I/O parity, watchdog timer, illegal instruction, LP check, others	
	Monitoring	Event history record, scan time measurement, others	
	Debugging	On-line trace monitor, force, sampling trace, status latch, single step/rung execution, break point setting, others	

## General Specifications

Item	Specification
Power supply voltage	100 to 240 Vac (+10/-15 %), 50/60 Hz 24 Vdc (+20/-15 %)
Power consumption	53 VA or less (ac power supply) 22 W or less (dc power supply)
Retentive power interruption	10 ms or less
Insulation resistance	10 MΩ or more (between power terminals and ground terminal)
Withstand voltage	1500 Vac - 1 minutes (between power terminals and ground terminal)
Ambient temperature	0 to 55 °C (operation) -20 to 75 °C (storage)
Ambient humidity	20 to 90 % RH (no condensation)
Noise immunity	1000 V p-p/1 μs, 89/336/EEC (EMC directive)
Vibration immunity	16.7 Hz - 3 mm p-p (3 mutually perpendicular axes)
Shock immunity	98 m/s <sup>2</sup> (10 g) (3 shocks per axis, 3 mutually perpendicular axes)
Standard	UL/c-UL, CE

## External Dimensions

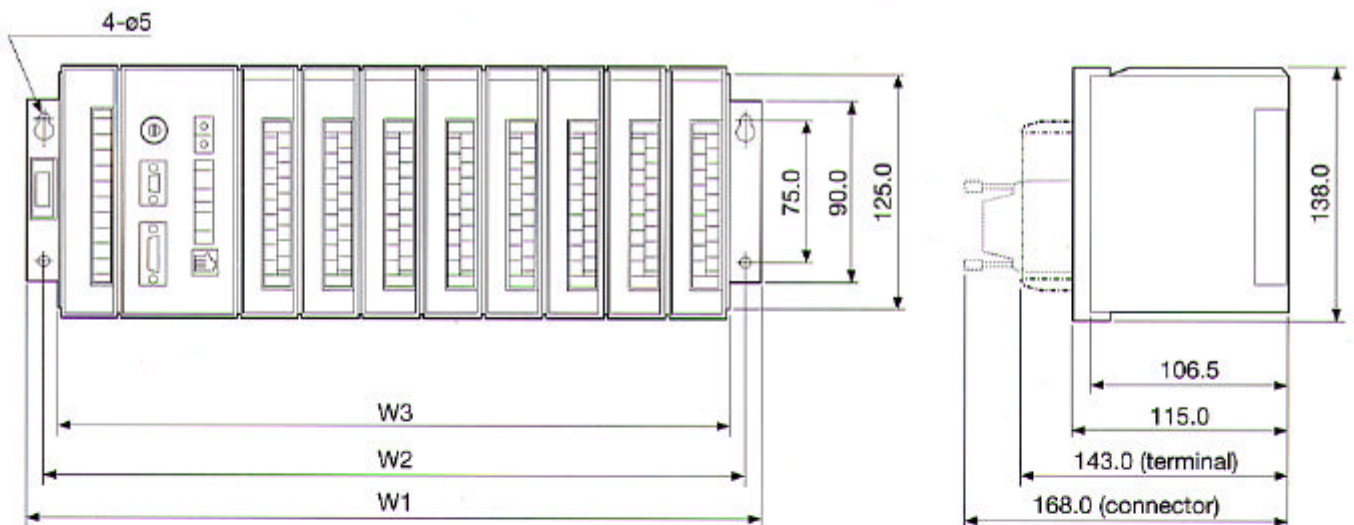

	BU228N	BU218	BU268	BU266	UBB2	UBB1	UBA2	UBA1
W3	366.0	366.0	300.0	234.0	300.0	201.0	300.0	201.0
W2	380.0	380.0	314.0	248.0	314.0	215.0	314.0	215.0
W1	394.0	394.0	340.0	274.0	328.0	229.0	328.0	229.0

Unit: mm

## I/O Module Specifications

### Digital Input

Item	DI31	DI32	DI235
Module type	DC input, current sink/source		
Input voltage	12 to 24 Vdc/ac, +10/-15%	24 Vdc, +10/-15%	
Min. ON voltage	9.6 V	18.0 V	16.0 V
Max. OFF voltage	3.6 V	6.0 V	5.0 V
Input current	8 mA (at 24 Vdc)	5 mA (at 24 Vdc)	4 mA (at 24 Vdc)
Input points	16 points (16/common)	32 points (4 x 8/common)	64 points (8 x 8/common)
ON delay	10 ms or less (dc, mode N) 1.5 ms or less (dc, mode H)	10 ms or less (mode N) 1.5 ms or less (mode H)	10 ms or less
OFF delay	10 ms or less (dc, mode N) 1.5 ms or less (dc, mode H)	10 ms or less (mode N) 1.5 ms or less (mode H)	15 ms or less

Item	IN51	IN61
Module type	AC input	
Input voltage	100 to 120 Vac, +10/15% (50/60 Hz)	200 to 240 Vac, +10/15% (50/60 Hz)
Min. ON voltage	80 Vac	160 Vac
Max. OFF voltage	30 Vac	60 Vac
Input current	7 mA (at 100 Vac)	6 mA (at 200 Vac)
Input points	16 points (16/common)	
ON delay	20 ms or less	
OFF delay	15 ms or less	

### Digital Output

Item	DO31	DO32	DO235	DO233P
Module type	DC output, current sink			DC output, current source
Output voltage	5 to 24 Vdc, +10/-5%		5 to 24 Vdc, ±10%	12 to 24 Vdc, ±10%
Load current	1 A/point (12/24 V) 0.3 A/point (5 V) 1.2 A/4 points	0.1 A/point (12/24 V) 0.02 A/point (5 V)	0.1 A point (12/24 V) 0.05 A/point (5 V)	1 A/point (12/24 V) 1.2 A/4 points
Output points	16 points (16/common)	32 points (4 x 8/common)	64 points (8 x 8/common)	16 points (16/common)
ON delay	1 ms or less	1 ms or less	1 ms or less	1 ms or less
OFF delay	1 ms or less	2 ms or less	1 ms or less	1 ms or less
Leakage current	0.1 mA or less (at 24 Vdc)			

Item	RO61	RO62	AC61
Module type	Relay contact output, normally open contact		AC output
Output voltage	24 Vdc, +20% / 240 Vac, +10% (max.)		100 to 240 Vac, +10/-15% (50/60 Hz)
Load current	2 A/point (resistive load) 4 A/common	2A/point (resistive load)	0.5 A/point 0.6 A/SSR (2 points)
Output points	12 points (3 x 4/common)	8 points (isolated)	12 points (3 x 4/common)
ON delay	10 ms or less		1 ms or less
OFF delay	15 ms or less		1/2 cycle + 1 ms or less
Leakage current	None		1.2 mA or less (at 100 Vac) 3 mA or less (at 240 Vac)

## Analog Input

Item	AI21	AI31	AI22	AI32
Input range	1 to 5 V / 4 to 20 mA	0 to 10 V	1 to 5 V / 4 to 20 mA	-10 to 10 V
Input impedance	1 to 5 V: 500 k $\Omega$ or more 4 to 20 mA: 250 $\Omega$	500 k $\Omega$ or more	1 to 5 V: 1 M $\Omega$ or more 4 to 20 mA: 250 $\Omega$	1 M $\Omega$ or more
Input channels	4 channels (4/common)			
Resolution	8-bit (0 to 250)		12-bit (0 to 4000)	12-bit (-2000 to 2000)
Conversion cycle	Approx. 1 ms/4 channels		Approx. 9.6 ms/4 channels	
Overall accuracy	$\pm 1$ % (full scale)		$\pm 0.5$ % (full scale)	

## Analog Output

Item	AO31	AO22	AO32
Output range	1 to 5 V / 4 to 20 mA / 0 to 5 V / 0 to 10 V	1 to 5 V / 4 to 20 mA	-10 to 10 V
Load impedance	5 V range: 5 k $\Omega$ or more 10 V range: 10 k $\Omega$ or more 20 mA range: 600 $\Omega$ or less	1 to 5 V: 5 k $\Omega$ or more 4 to 20 mA: 600 $\Omega$ or less	5 k $\Omega$ or more
Output channels	2 channels (2/common)		
Resolution	8-bit (0 to 250)	12-bit (0 to 4000)	12-bit (-2000 to 2000)
Conversion cycle	Approx. 1 ms/2 channels		
Overall accuracy	$\pm 1$ % (full scale)	$\pm 0.5$ % (full scale)	

## Pulse Input

Item	PI21
Input channels	1 channel (phase A, B, and M)
Input voltage	5 / 12 V, +10%/-20%
Input current	10 mA (5 V) 7.5 mA (12 V)
Counting speed	100 k pps max.
Count data	24-bit binary (-8388608 to 8388607)
Pulse input mode	Quadrature (90° phase shift), Up/down (A: up / B: down)

## Communication Interface

Item	CF211
Interface	RS-232C, 1 port
Transmission system	Full-duplex
Transmission code	ASCII
Transmission speed	300, 600, 1200, 2400, 4800, 9600, or 19200 bps
Framing	Start bit: 1 bit Data bits: 7 or 8 bits Parity: Odd, even, or none Stop bit: 1 or 2 bits
Message length	320 bytes max.

## Position Control

Item	MC11
Control axes	1 axis
Control units	Pulse, mm, inch, degree, etc.
Control range	$\pm 999,999$ (specified unit)
Pulse output speed	200 k pps max.
Input signals	Zero-marker, over-travel limit, emergency stop, etc.
Input voltage	12 / 24 Vdc (10 mA)
Pulse output	CW and CCW, Pulse and Direction
Output voltage	5 to 24 Vdc (50 mA)
Parameters	Acceleration/deceleration rate, backlash compensation, etc.
Parameter backup	EEPROM

# Ordering Information

Item	Description		Type	Part number	
T2E CPU module	9.5 k steps, flash memory, clock/calendar		PU234E	TPU234E+S	
T2E CPU add-on option card	Communication card RS-485, with battery		CM231E	TCM231EAS	
	Communication card RS-232C, with battery		CM232E	TCM232EAS	
	Battery card, with battery		BT231E	TBT231EAS	
T2N CPU module	Standard type, 23.5 k steps, flash memory, clock/calendar, RS-232C/RS-485 communication port, with battery		PU215N	TPU215N+S	
	Standard type plus Ethernet		PU235N	TPU235N+S	
	Standard type plus Ethernet and TOSLINE-S20LP		PU245N	TPU245N+S	
CPU rack	For T2E	Non expandable	4 I/O slots	UBA1	EX10+UBA1
			7 I/O slots	UBA2	EX10+UBA2
		Expandable	4 I/O slots	UBB1	EX10+UBB1
	7 I/O slots		UBB2	EX10+UBB1	
	8 I/O slots		BU218	TBU218+S	
	For T2N	Expandable	8 I/O slots	BU228N	TBU228N+S
Expansion rack	6 I/O slots		BU266	TBU266+S	
	8 I/O slots		BU268	TBU268+S	
Power supply	100 to 240 Vac		PS261	TPS261+S	
	24 Vdc		PS31	EX10+MPS31	
I/O module	DC input	16 points, 12 to 24 Vdc/ac, 8 mA	DI31	EX10+MDI31	
		32 points, 24 Vdc, 5 mA (connector type)	DI32	EX10+MDI32	
		64 points, 24 Vdc, 4 mA (connector type)	DI235	TDI235+S	
	AC input	16 points, 100 to 120 Vac, 7 mA	IN51	EX10+MIN51	
		16 points, 200 to 240 Vac, 6 mA	IN61	EX10+MIN61	
	Relay output	12 points, 24 Vdc/240 Vac, 2 A/point	RO61	EX10+MRO61	
		8 points (isolated), 24 Vdc/240 Vac, 2 A/point	RO62	EX10+MRO62	
	DC output	16 points, 5 to 24 Vdc, 1 A/point	DO31	EX10+MDO31	
		32 points, 5 to 24 Vdc, 0.1 A/point (connector)	DO32	EX10+MDO32	
		64 points, 5 to 24 Vdc, 0.1 A/point (connector)	DO235	TDO235+S	
		16 pts, 12 to 24 Vdc, 1 A/point, current source	DO233P	TDO233P+S	
	AC output	12 points, 100 to 240 Vac, 0.5 A/point	AC61	EX10+MAC61	
	Analog input	1 to 5 V/4 to 20 mA, 8-bit resolution	AI21	EX10+MAI21	
		0 to 10 V, 8-bit resolution	AI31	EX10+MAI31	
		1 to 5 V/4 to 20 mA, 12-bit resolution	AI22	EX10+MAI22	
		-10 to 10 V, 12-bit resolution	AI32	EX10+MAI32	
	Analog output	1 to 5 V/4 to 20 mA/0 to 10 V, 8-bit resolution	AO31	EX10+MAO31	
		1 to 5 V/4 to 20 mA, 12-bit resolution	AO22	EX10+MAO22	
		-10 to 10 V, 12-bit resolution	AO32	EX10+MAO32	
	1 channel pulse input, 5/12 V, 100 k pps max.		PI21	EX10+MPI32	
	1 axis position control, pulse train output, 200 k pps max.		MC11	EX10+MMC11	
	Communication interface, RS-232C, 1 port		CF211	TCF211+S	
	Network	TOSLINE-S20	Co-axial cable type station for T2E/T2N	SN221	SSN221+MS
Fiber optic type station for T2E/T2N			SN222A	SSN222AMS	
TOSLINE-F10		Master station for T2E/T2N	MS211	FMS211AM	
		Remote station for T2E/T2N	RS211	FRS211AM	
		Remote input block, 16 points, 24 Vdc	DI633	FDI633+K	
		Remote output block, 16 points, relay	RO663	FRO663+K	
		Remote output block, 16 points, 24 Vdc	DO633	FDO633+K	
DeviceNet scanner module for T2E/T2N		DN211	TDN211+S		

Item	Description		Type	Part number
Expansion cable	0.3 m length		CAR3	EX10•CAR3
	0.5 m length		CAR5	EX10•CAR5
	0.7 m length		CAR7	EX10•CAR7
	1.5 m length		CS2RF	TCS2RF•CS
Peripheral tool	Programming software (T-PDS)	For MS-DOS	T-PDS	TMM33I1SS
		For Windows 3.1/95	T-PDS Win	TMW33E1SS
	Handy programmer with 2 m cable for T2E/T2N		HP911	THP911•S
	Configuration software for TOSLINE-S20/S20LP (S-LS)	For MS-DOS (S20 only)	S-LS	SMM23I•SS
		For Windows 95 (S20/S20LP)	S-LS Win	SMW23E•SS
Program storage module		RM102	TRM102•S	
Peripheral cable	5 m cable for T-PDS or S-LS		CJ905	TCJ905•CS
Miscellaneous	Empty slot cover		—	EX10•ABP1
	RS-232C/RS-485 converter		ADP-6237B	EX25PADP6237B
	Spare battery		—	EX25SER6

# Quality

Quality is a religion at Toshiba. Quality starts at the very basic level, the IC (integrated circuit), and proceeds through design development and manufacturing of all types consumer and industrial products.



Toshiba corporation's quality management system in design, development and manufacturing of programmable controllers is approved to satisfy the quality management standard ISO9001.



### Safety Precaution

**This product is intended to be used for the control of industrial machines and processes.  
Misuse of this product can result in property damage or human injury.  
Read related manuals carefully before using this product.**

PROSEC and TOSLINE are registered trademarks of TOSHIBA Corporation.  
IBM is a registered trademark of International Business Machines Corporation.  
MS-DOS and Windows are registered trademarks of Microsoft Corporation.  
Ethernet is a registered trademark of Xerox Corporation.  
DeviceNet is a trademark of the Open DeviceNet Vender Association, Inc.

For further information, please contact your nearest Toshiba Representative or International Operations-Producer Goods.

The data given in this brochure are subject to change without notice.

In Touch with Tomorrow  
**TOSHIBA**

**TOSHIBA CORPORATION**  
Industrial Equipment Department  
1-1, Shibaura 1-chome, Minato-ku, Tokyo 105, Japan  
Tel.: (03)3457-4900 Fax.: (03)5444-9268

**Toshiba International Corporation**  
Industrial Division  
Houston U.S.A.  
Tel.: 713-466-0277  
Fax.: 713-466-8773

**Toshiba International Corporation (Europe) Ltd.**  
Middlesex U.K.  
Tel.: 0181-756-6000  
Fax.: 0181-848-4969

**Toshiba International Corporation Pty., Ltd.**  
Sydney Australia  
Tel.: 02-428-2077  
Fax.: 02-427-7405/6

**Toshiba Asia Pacific Pte., Ltd.**  
Singapore  
Tel.: 65-324-1048  
Fax.: 65-324-5286